

LED Driver

EUCI LITE Series

EUCI LITE



Highlights & Features

- Wireless configuration interface via NFC
- DALI-2 certified LED driver with Part 207/251/253
- Constant power mode design and wide range of output current adjustable: 200mA - 1050mA
- Programmable functions: AOC/CLO/MTP/EOL
- Autonomous dimming includes three "Smart Timer Dim" Operate with Fixed Timer, Midnight Centric Timer and Ratio Rescale Timer
- Corridor mode operate with a DALI master or GUI software
- Robustness protection against vibration, harsh operating temperature and moisture with potting
- Override function is used to force the output dimming to the given level in any of Smart Timer Dim modes at any given time when DALI dimming command is received
- High Efficiency Up to 94%
- High surge immunity protection (10K V/ 6K V)
- Meet Zhaga dimension criteria

Safety Standards



Dimensions (L x W x H):

EUCI-022105GLB	133.0 x 77.0 x 40.0 mm (5.24 x 3.00 x 1.57 inch)
EUCI-040105GLB	133.0 x 77.0 x 40.0 mm (5.24 x 3.00 x 1.57 inch)
EUCI-075105GLB	133.0 x 77.0 x 40.0 mm (5.24 x 3.00 x 1.57 inch)
EUCI-130105GLB	150.0 x 90.0 x 40.0 mm (5.91 x 3.54 x 1.57 inch)
EUCI-170105GLB	170.0 x 100.0 x 40.0 mm (6.6 x 3.94 x 1.57 inch)

General Description

Delta LED drivers come in different series to suit different application needs. The EUCI LITE series features programmable output current levels. The EUCI LITE series offers the capability to achieve different level of LED brightness via built-in DALI-2 function to meet various application and energy optimization needs. These products are designed and rigorously tested to work with various outdoor LED lighting conditions. Featuring high surge immunity (CM: 10kV, DM: 6kV), which makes Delta EUCI LITE series an essential part of an energy efficient LED lighting power solution for both Industrial and outdoor applications.

Model Information

EUCI LITE LED Driver

Model Number	Input Voltage Range	Rated Output Voltage	Program Output Current Range	Constant Power Current Range
EUCI-022105GLB	220-240 Vac Typical 198-264 Vac Range	8-48 Vdc	200-1050 mA	460-1050 mA
EUCI-040105GLB		20-77 Vdc	200-1050 mA	520-1050 mA
EUCI-075105GLB		35-150 Vdc	200-1050 mA	500-1050 mA
EUCI-130105GLB		60-200 Vdc	200-1050 mA	650-1050 mA
EUCI-170105GLB		80-310 Vdc	200-1050 mA	550-1050 mA

Model Numbering

EU	C	I	-	□□□	□□□	G	L	B
Safety Approval CE, ENEC	Constant current	Industrial		Output Power 022 - 22 W 040 - 40 W 075 - 75 W 130 - 130 W 170 - 170 W	Output Current 105-1050 mA	Programmable output current (by NFC or Programmer)	Control type DALI-2 dimming	B Standard

LED Driver

EUCI LITE Series

Specifications

Model Number	EUCI-022105GLB	EUCI-040105GLB	EUCI-075105GLB	EUCI-130105GLB	EUCI-170105GLB
--------------	----------------	----------------	----------------	----------------	----------------

Input Ratings / Characteristics

Normal Input Voltage	220-240 Vac					
Input Voltage Range	198-264 Vac					
Normal Input Frequency	50-60 Hz					
Input Frequency Range	47-63 Hz					
Max. Input Current	230 Vac	0.12 A	0.23 A	0.43 A	0.68 A	0.87 A
Efficiency ¹⁾	230 Vac	90% @ 0.46 A	90% @ 0.52 A	92% @ 0.5 A	93% @ 0.7 A	94% @ 0.55 A
	230 Vac	86% @ 1.05 A	87% @ 1.05 A	90% @ 1.05 A	92% @ 1.05 A	93% @ 1.05 A
Inrush Current (Apk / 50%-us) (Cold Start)	230 Vac	20 A/250 uS	20 A/250 uS	20 A/250 uS	40 A/250 uS	60 A/250 uS
Max. No. of LED Drivers circuit breaker @ 230Vac	B10	18 pcs	18 pcs	15 pcs	10 pcs	8 pcs
	B16	28 pcs	28 pcs	25 pcs	16 pcs	12 pcs
	C10	30 pcs	30 pcs	15 pcs	10 pcs	8 pcs
	C16	46 pcs	46 pcs	25 pcs	16 pcs	12 pcs
Total Harmonic Distortion(Typical)	< 13%		< 8%	< 8%	< 7%	< 6%
	@ 230 Vac, 100% load					
Power Factor	> 0.95 @ 230 Vac, 100% load					
Leakage Current	< 0.7 mA peak @ 230 Vac					
Standby Power	0.5W @ DALI standby mode, 230 Vac					
Input Over-Voltage	Can survive input over-voltage stress of 320 Vac for 48 hours and 350 Vac for 2 hours					

Output Ratings / Characteristics

Output Voltage Range	8-48 Vdc	20-77 Vdc	35-150 Vdc	60-200 Vdc	80-310 Vdc
Max. No Load Output Voltage	90 V	120 V	210 V	350 V	430 V
Output Power Range	22 W	40 W	75 W	130 W	170 W
Adjustable Output Current (AOC)	200-1050 mA	200-1050 mA	200-1050 mA	200-1050 mA	200-1050 mA
	With steps of 1 mA, configurable via software				
Physical Minimum Output Current	35 mA (Min dim level)				
Current Accuracy	± 5% @ 0.46~1.05 A	± 5% @ 0.52 A~1.05 A	± 5% @ 0.5 A~1.05 A	± 5% @ 0.65 A~1.05 A	± 5% @ 0.55 A~1.05 A
Line Regulation	± 3% (@ 220-240 Vac)				
Load Regulation	± 5% (@ Min-Max output voltage)				
Output Current LF Ripple	4% (ripple = peak-average/average) at full load, (<100 Hz)				
Start-up Time	520~1000 ms max. (@ 220-240 Vac)				

LED Driver

EUCI LITE Series

Model Number	EUCI-022105GLB	EUCI-040105GLB	EUCI-075105GLB	EUCI-130105GLB	EUCI-170105GLB
--------------	----------------	----------------	----------------	----------------	----------------

Mechanical

Casing	Plastic, Color : Black				
Dimensions (L x W x H)	[mm]	133.0 x 77.0 x 40.0		150.0 x 90.0 x 40.0	170.0x100.0x40.0
	[inch]	5.24 x 3.03 x 1.57		5.91 x 3.54 x1.57	6.69 x 3.94 x 1.57
Unit Weight	[kg]	0.55		0.75	0.98
	[lb]	1.20		1.65	2.16
Weight/carton	[kg]	11.4		9.5	10.3
Pieces per carton box		20 pcs	20 pcs	20 pcs	12 pcs
Cooling System	Convection				
Input connector(22/40/75W)	Terminal, 5-pole with push-button, Conductor 0.5~2.5 mm ² , Strip length 10...11mm Line : Black, Neutral : White, Space*2 : Gray, EUQI : Green				
Input connector(130/170W)	Terminal, 2-pole with push-button, Conductor 0.5~2.5 mm ² , Strip length 10...11mm Line : Black, Neutral : White				
Output connector(22/40/75W)	Terminal, 6-pole, Conductor 0.5~1.5 mm ² , Strip length 8.5...9.5mm LED+ : Red, LED- : Black, GND : White, MTP : Light blue, DALI*2 : Blue				
Output connector(130W)	Terminal, 9-pole, Conductor 0.5~1.5 mm ² , Strip length 8.5...9.5mm EQUI: Green, Space*2: Gray, LED+: Red, LED-: Black, MTP: Light blue, GND: White, DALI*2: Blue				
Output connector(170W)	Terminal, 10-pole, Conductor 0.5~1.5 mm ² , Strip length 8.5...9.5mm EQUI: Green, Space*2: Gray, LED+: Red, LED-: Black, MTP: Light blue, GND: White, Space*1: Gray, DALI*2: Blue				
Max cable length	2m (between driver and LED module)				
Noise (30cm distance)	Sound Pressure Level (SPL) < 24dBA				

Environment

Ambient Temperature	Operating	-40°C to +55°C			
	Storage	-40°C to +85°C			
Maximum Case Temperature		+85°C	+90°C	+90°C	+90°C
Lifetime @ tc		+75°C	+80°C	+80°C	+80°C
Relative Humidity	Operating	10 to 90% RH (Non-Condensing)			
	Storage	5 to 95% RH (Non-Condensing)			

Protections

	90 V	120 V	210 V	350 V	430 V
Over Voltage	Luminaries will work normally when the fault is removed				
Overload / Overcurrent	Reduce output current. Auto-Recovery when the fault is removed				
Short Circuit	Auto-Recovery when the fault is removed				
Over Temperature	Reduce output current. Auto-Recovery when the fault is removed				
Ingress Protection Classification	IP20				
Suitable for Luminaires Class	Class I/Class II. Insulation Class according to IEC 60598				

LED Driver

EUCI LITE Series

Model Number	EUCI-022105GLB	EUCI-040105GLB	EUCI-075105GLB	EUCI-130105GLB	EUCI-170105GLB
--------------	----------------	----------------	----------------	----------------	----------------

Reliability Data

Lifetime	50,000 hours @ Maximum Case Temperature (Please refer to lifetime VS Case temperature) 100,000 hours @ Maximum Case Temperature -10deg
MTTF	1,000,000 hours for 22 W/40 W , 830,000 hours for 75 W 690,000 hours for 130 W, 475,000 hours for 170 W @Ta=+55°C (as per Telcordia SR-332, total failure rate less than10%)

Safety Standards / Directives

Electrical Safety	IEC 61347-1, IEC 61347-2-13 (Built-in) EN 61347-1, EN 61347-2-13 EN IEC 62384 SELV (for 22 W/40 W)			
CE	In conformance with EMC Directive and Low Voltage Directive			
Material and Parts	RoHS Directive 2011/65/EU Compliant			

Galvanic Isolation (20/40/75W)	Mains	EQUI	LED+MTP	DALI
Mains	N/A	Double	Double	Basic
EQUI	Double	N/A	Basic	Supplementary
LED+MTP	Double	Basic	N/A	Supplementary
DALI	Basic	Supplementary	Supplementary	N/A

Galvanic Isolation (130/170W)	Mains	EQUI	LED+MTP	DALI
Mains	N/A	Double	Double	Basic
EQUI	Double	N/A	Basic	Supplementary
LED+NTC	Double	Basic	N/A	Supplementary
DALI	Basic	Supplementary	Supplementary	N/A

EMC

Emissions (CE & RE)	Compliance to EN 55015 Class B	
Immunity	Compliance to EN 61547	
Electrostatic Discharge	IEC 61000-4-2	Air Discharge: 8kV Contact Discharge: 4kV Criteria A ¹⁾ or Criteria B ²⁾
Radiated Disturbances	IEC 61000-4-3	80 MHz-1GHz, 3 V/m with 1 kHz Sine Wave / 80% Modulation Criteria A ¹⁾
Electrical Fast Transient / Burst	IEC 61000-4-4	1KV, Criteria A ¹⁾ or Criteria B ²⁾
Surge	IEC 61000-4-5	Common Mode ³⁾ : 10kV; Differential Mode ⁴⁾ : 6kV, Criteria A ¹⁾ or Criteria B ²⁾
Conducted Disturbances	IEC 61000-4-6	50 kHz-80 MHz, 3 Vrms ,Criteria A ¹⁾
Power Frequency Magnetic Fields	IEC 61000-4-8	3 A/Meter, Criteria A ¹⁾
Voltage Dips	IEC 61000-4-11	100% dip; 0.5 cycle, Criteria A ¹⁾ or Criteria B ²⁾ 30% dip; 10 cycle, Criteria A ¹⁾ or Criteria B ²⁾
Harmonic Current Emission	IEC 61000-3-2	Class C (230Vac @ ≥ 50% load)
Voltage Fluctuation & Flicker	IEC 61000-3-3	Pst <1, Plt <0.65

1) Criteria A: Normal performance within the specification limits

2) Criteria B: Temporary degradation or loss of function, which is self-recoverable

3) Asymmetrical: Common mode (Line to earth)

4) Symmetrical: Differential mode (Line to line)

LED Driver

EUCI LITE Series

Model Number	EUCI-022105GLB	EUCI-040105GLB	EUCI-075105GLB	EUCI-130105GLB	EUCI-170105GLB
--------------	----------------	----------------	----------------	----------------	----------------

Default Settings of the Driver (can be changed with programmable tools)

Adjustable Output Current (AOC)	460 mA	520 mA	500 mA	650 mA	550 mA
Smart Timer DIM	Disabled. Settable though programmable tools				
Module Temperature Protection (MTP)	Disabled. Settable though programmable tools				
Constant Lumen Output (CLO)	Disabled. Settable though programmable tools.				
End of Life indication (EOL)	Disabled. Settable though programmable tools				
Auxiliary Output	N/A				

DALI Specification

Dimming range	0, 5-100% (Dim to off)
Standards	DALI-2 IEC 62386-101 Ed 2.0 IEC 62386-102 Ed 2.0 IEC 62386-207 Ed 2.0(DT6) IEC 62386-251: Memory bank 1 extension (luminaire data) IEC 62386-253: Diagnostics and maintenance

Note: EUCI-022105GLB/EUCI-040105GLB update with EN62386-251/253 functions and release from Jan 2025 production lot.

LED Driver

EUCI LITE Series

Lifetime VS Case Temperature

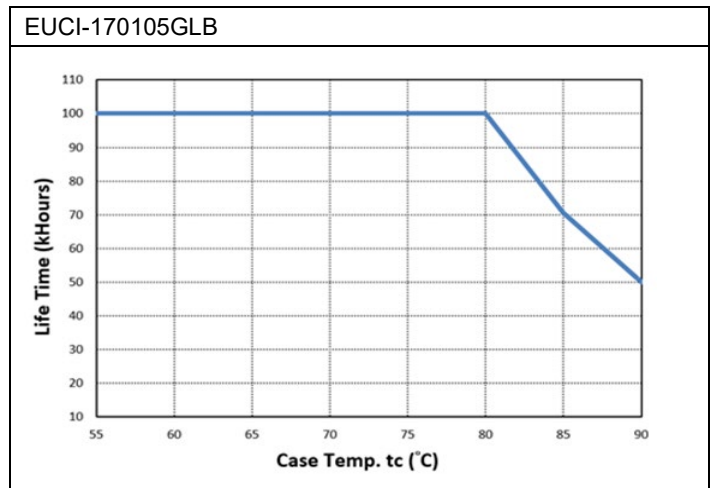
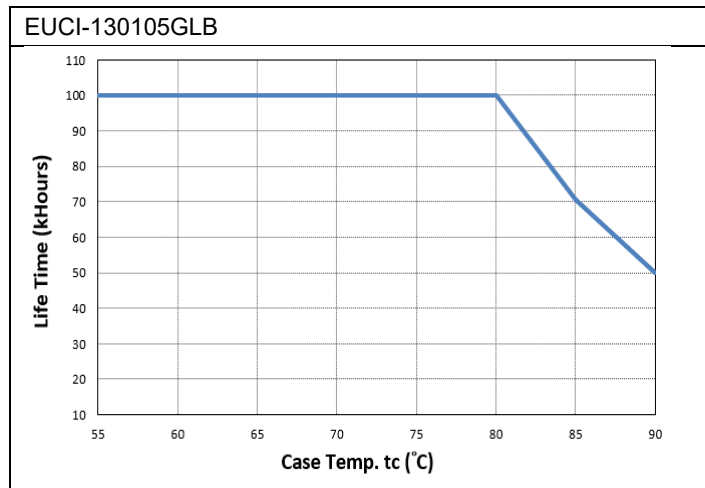
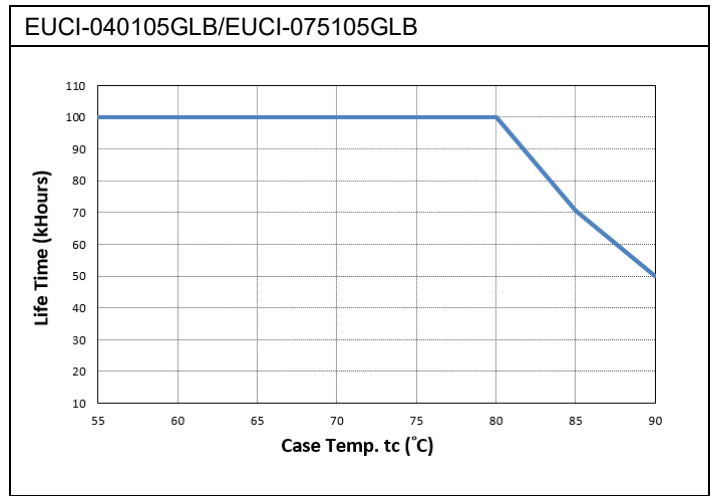
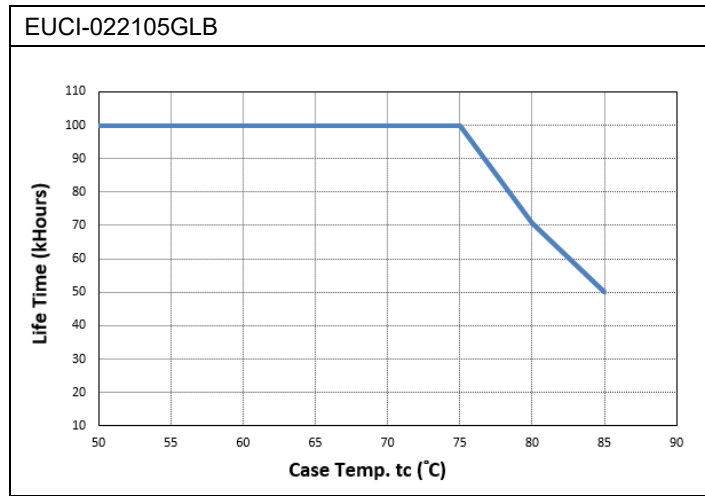

LED Driver

EUCI LITE Series

Output and Dimming Characteristic Curve

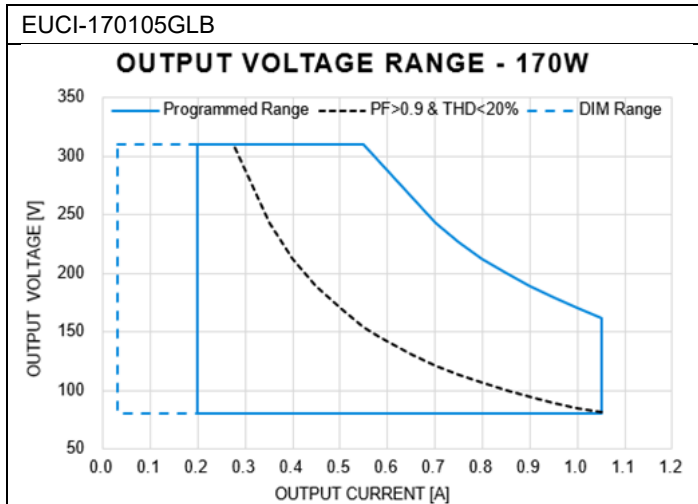
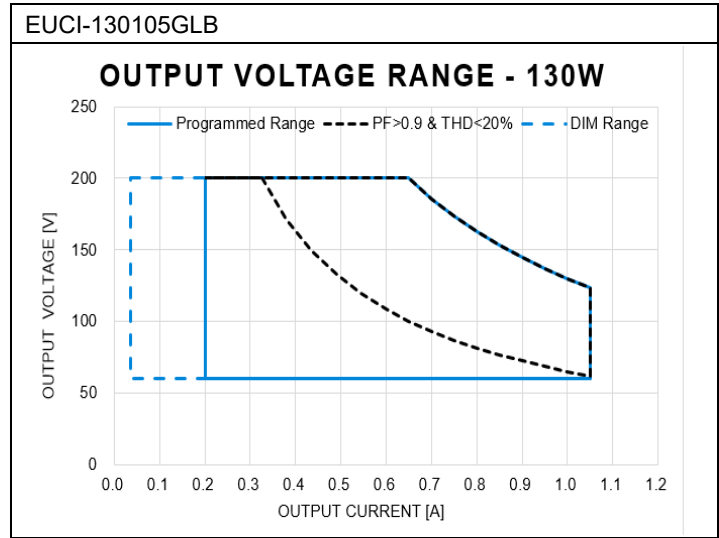
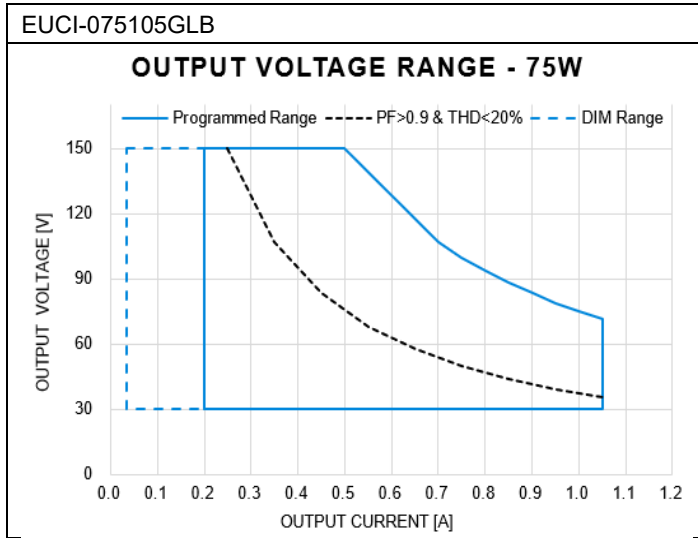
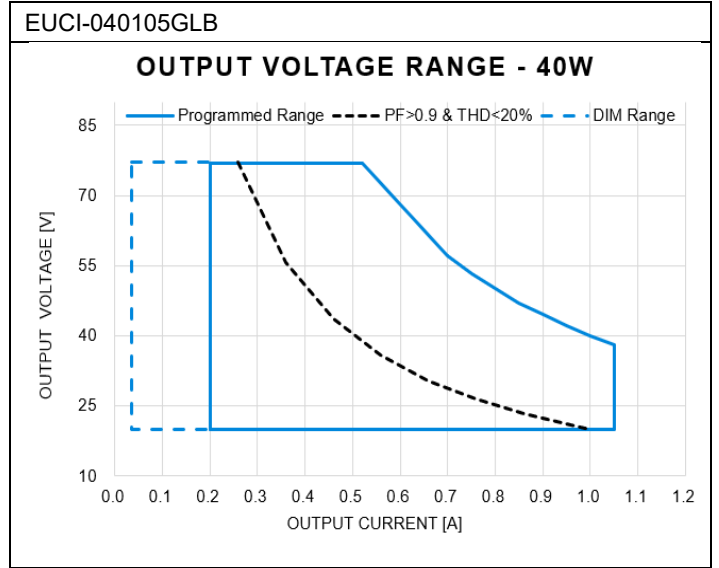
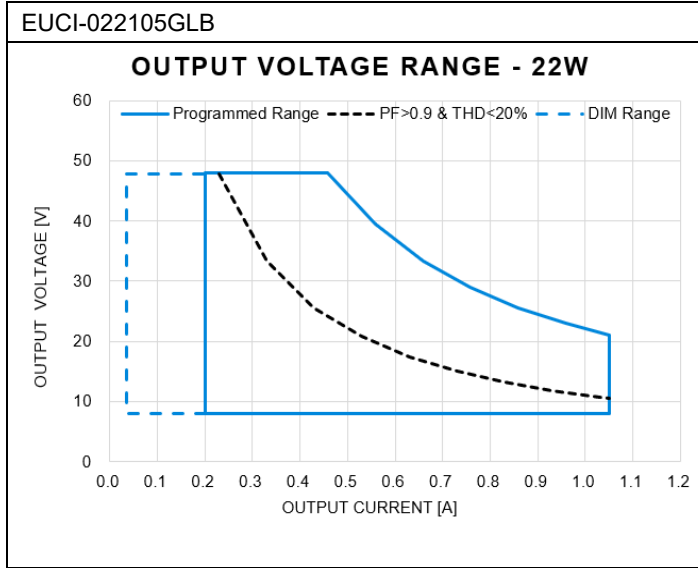

LED Driver

EUCI LITE Series

Efficiency VS Output Power

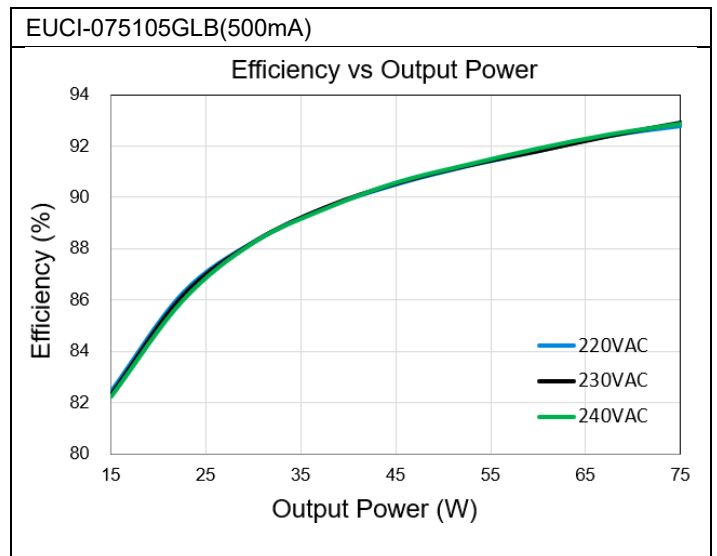
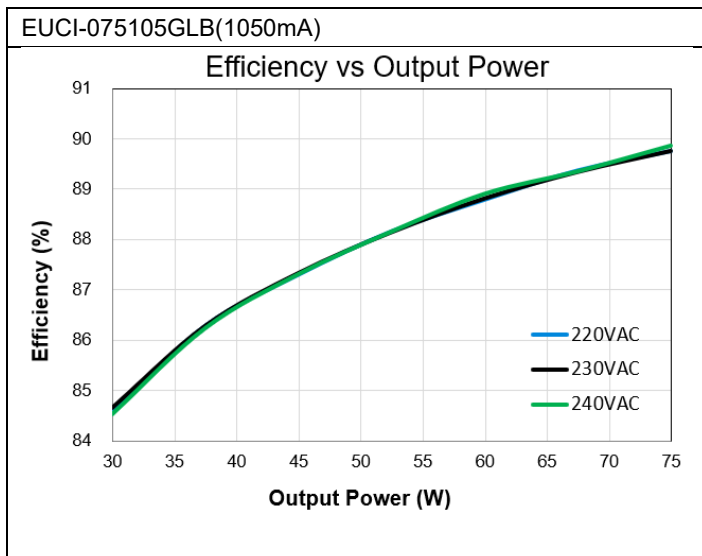
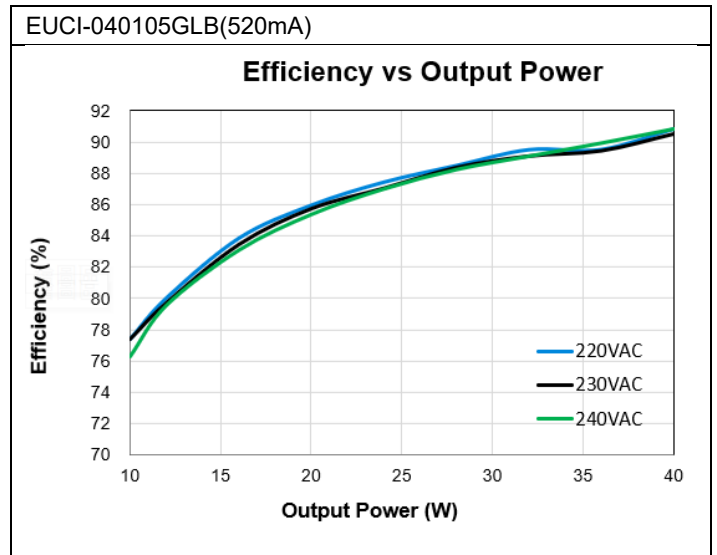
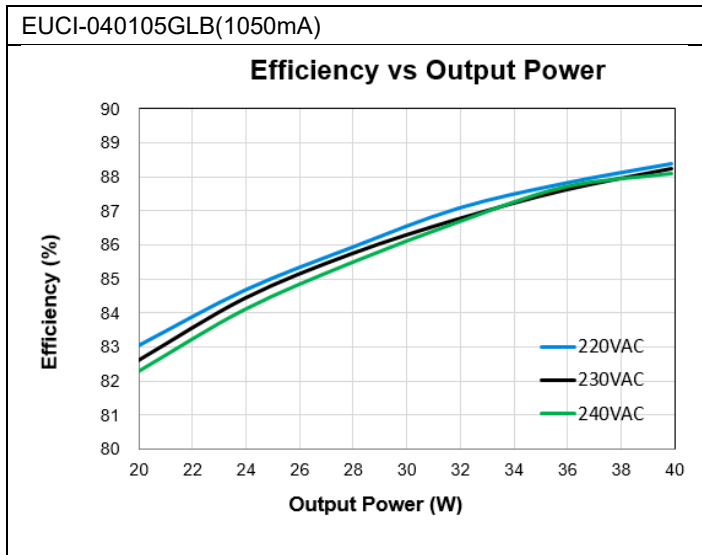
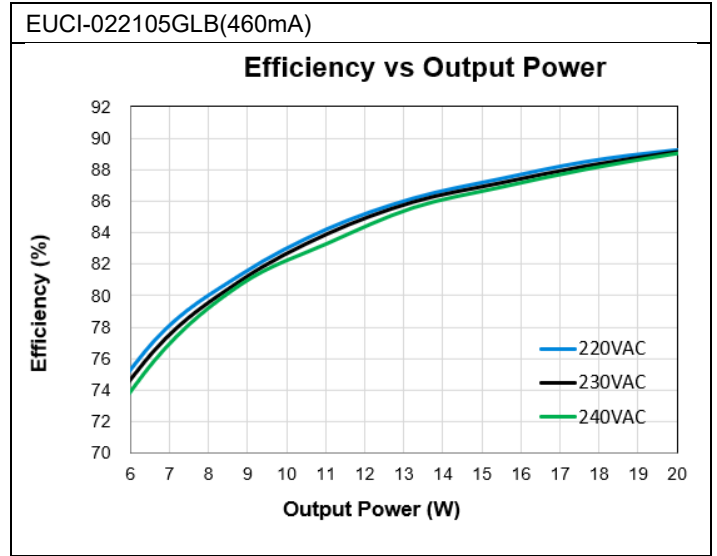
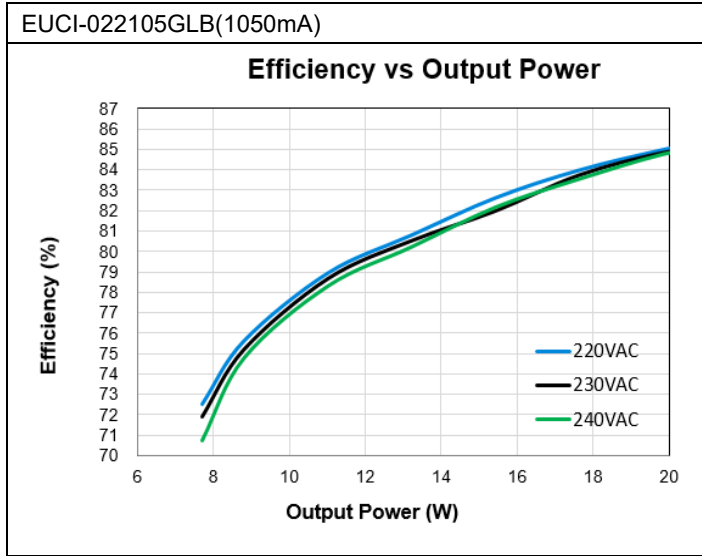

LED Driver

EUCI LITE Series

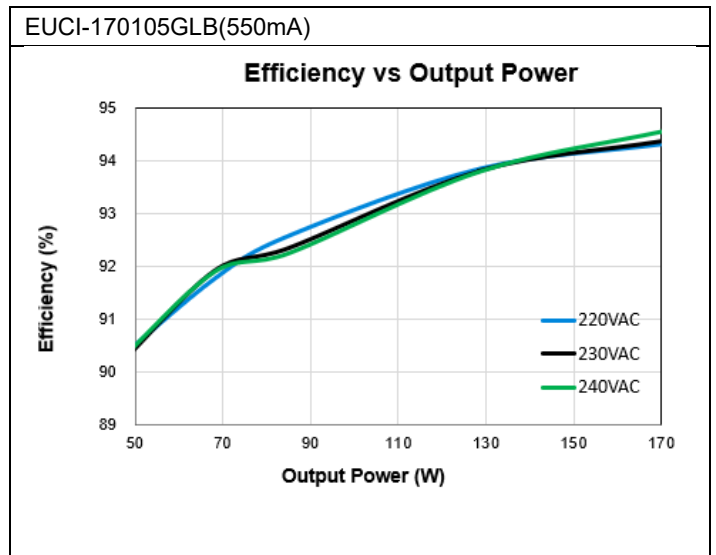
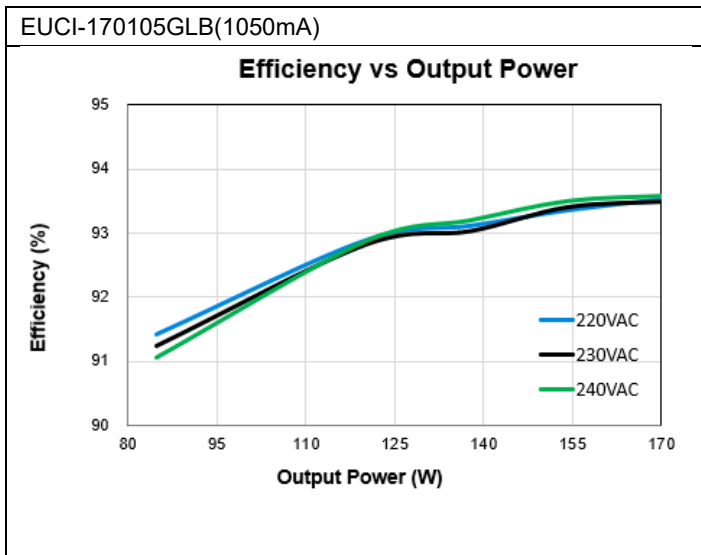
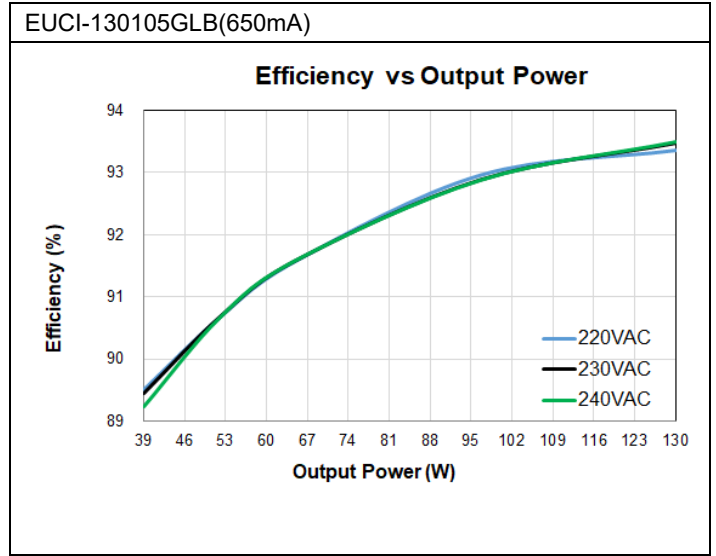
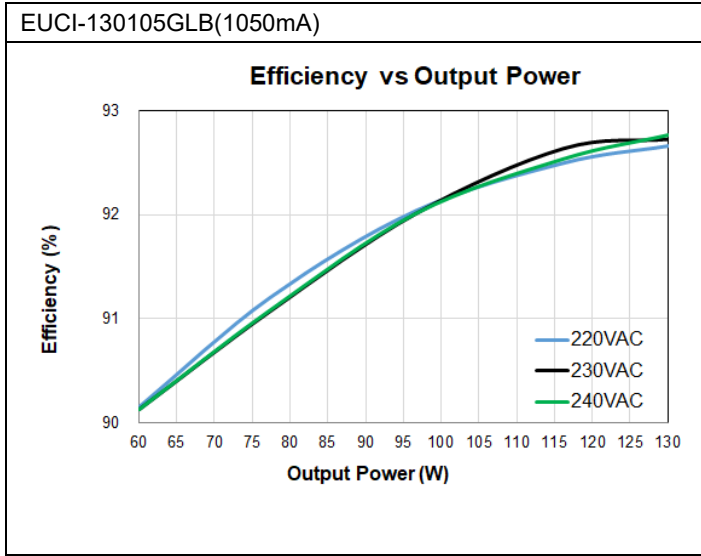

LED Driver

EUCI LITE Series

Power Factor VS Output Power

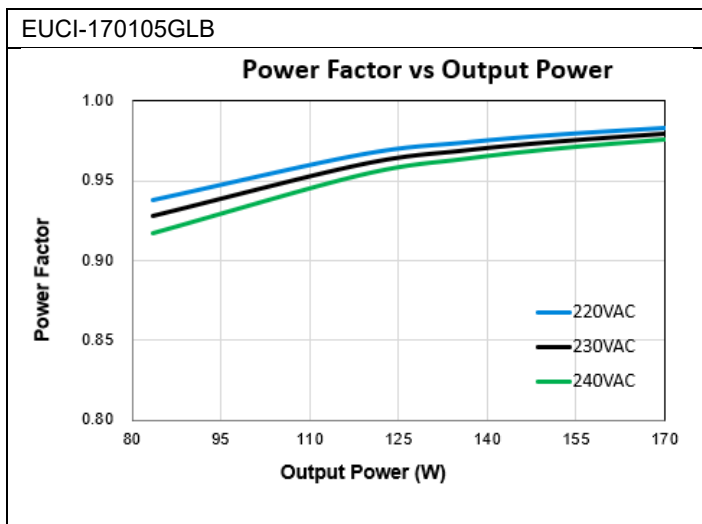
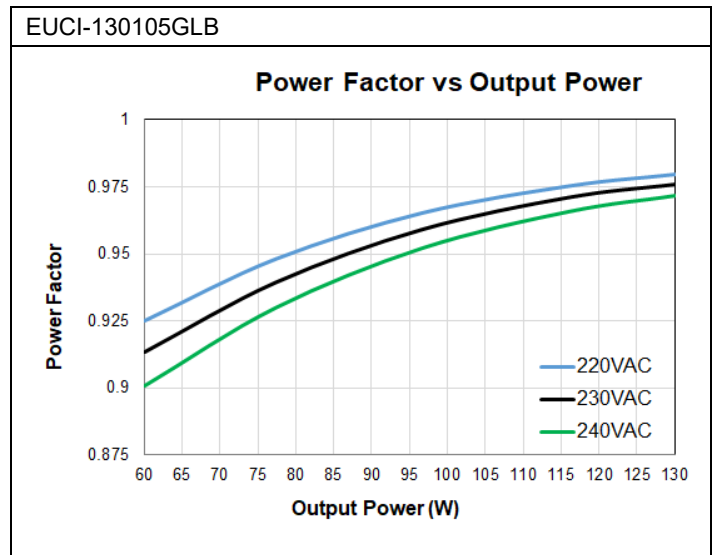
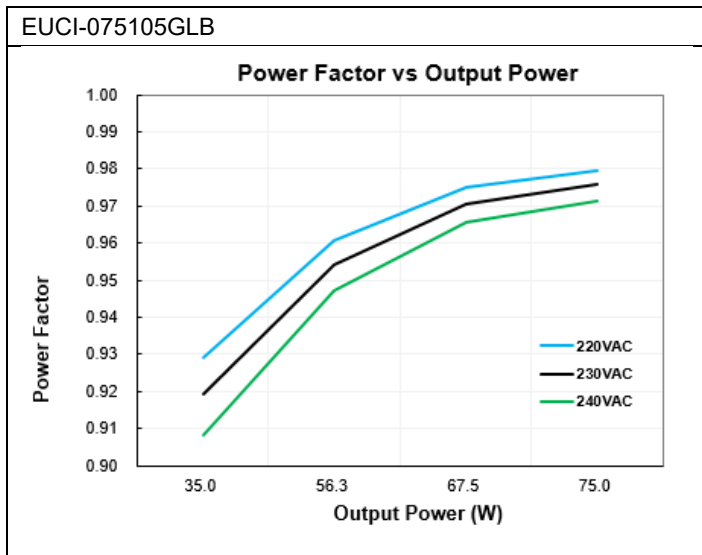
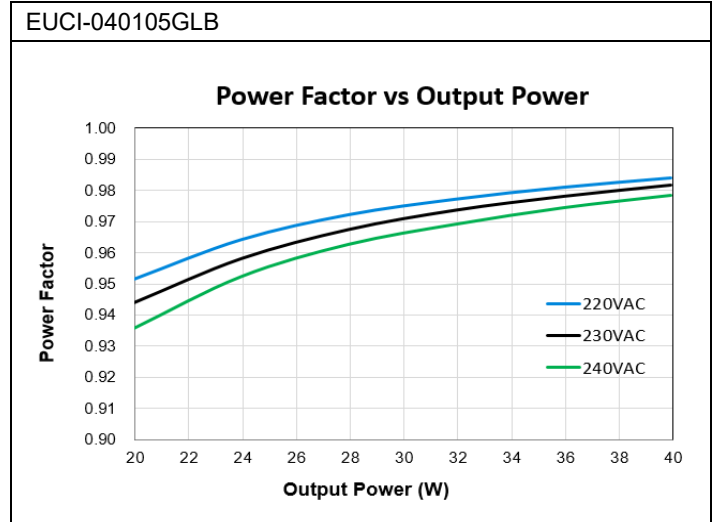
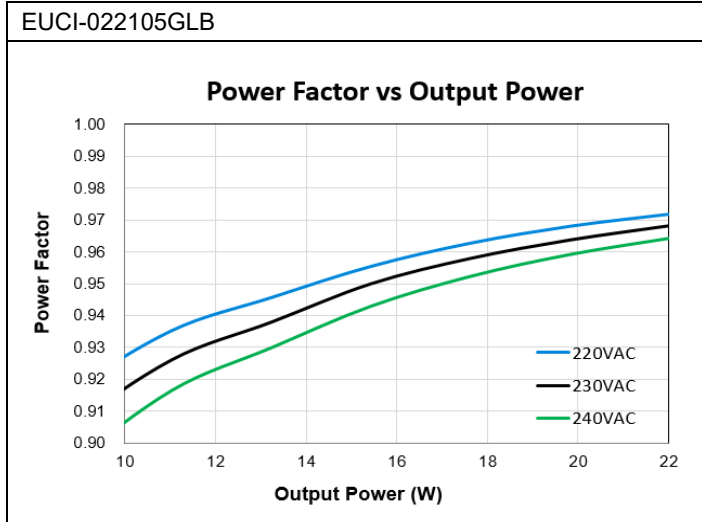

LED Driver

EUCI LITE Series

Total Harmonic Distortion VS Output Power

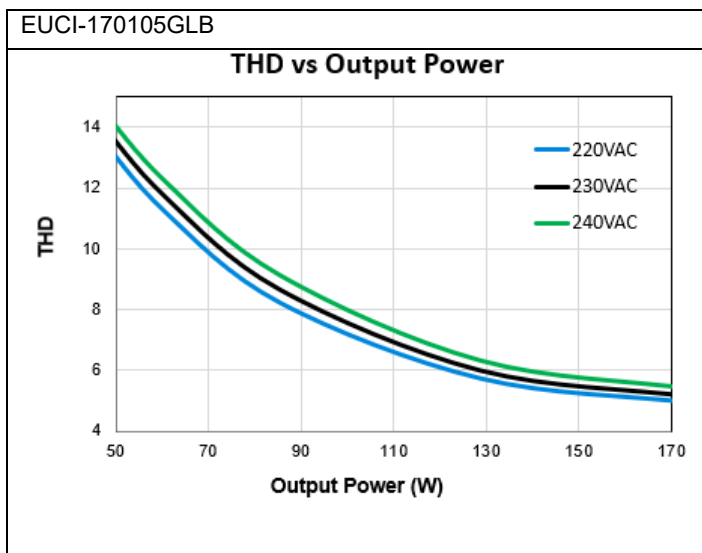
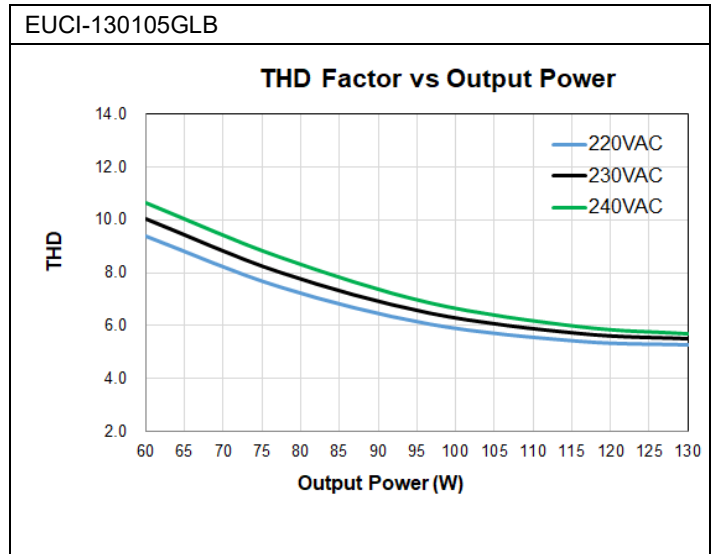
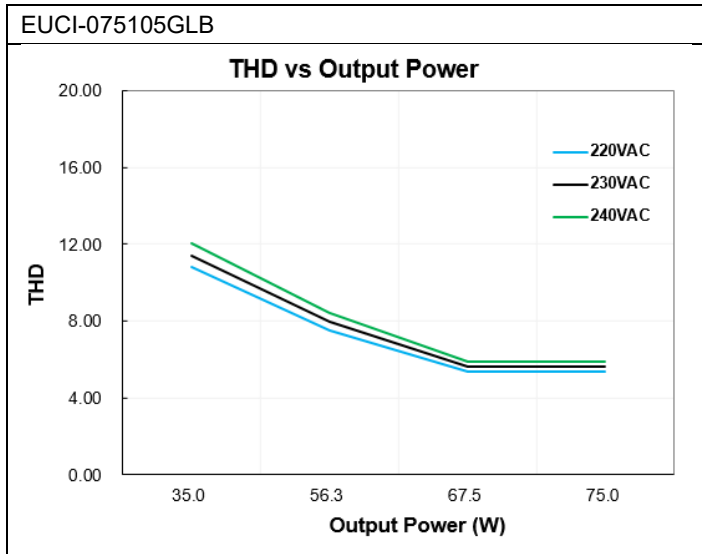
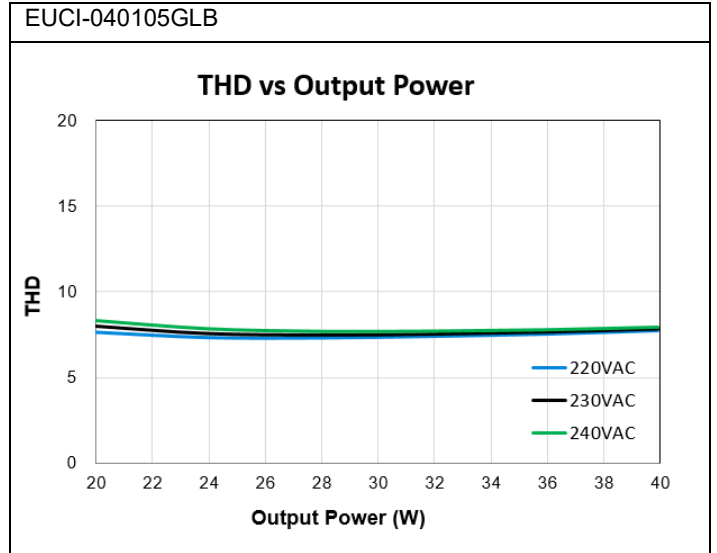
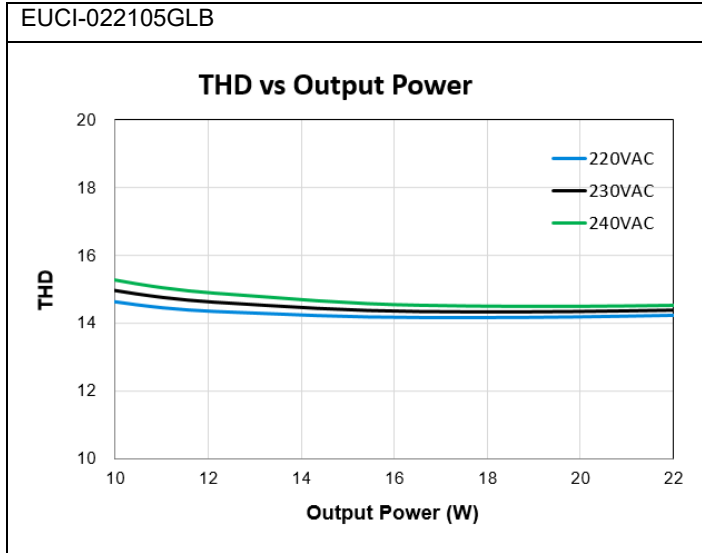

LED Driver

EUCI LITE Series

Dimensions

EUCI-022105GLB & EUCI-040105GLB & EUCI-075105GLB

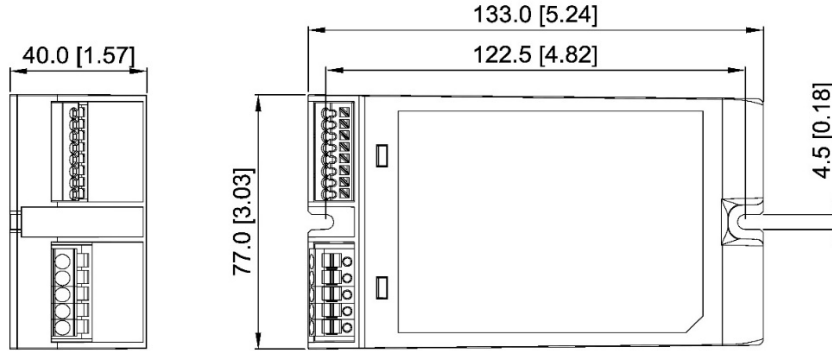

Unit: mm [inch]

EUCI-130105GLB

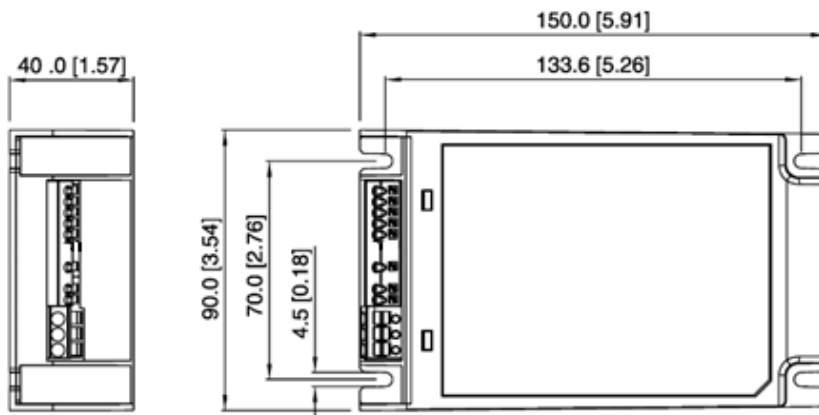

Unit: mm [inch]

EUCI-170105GLB

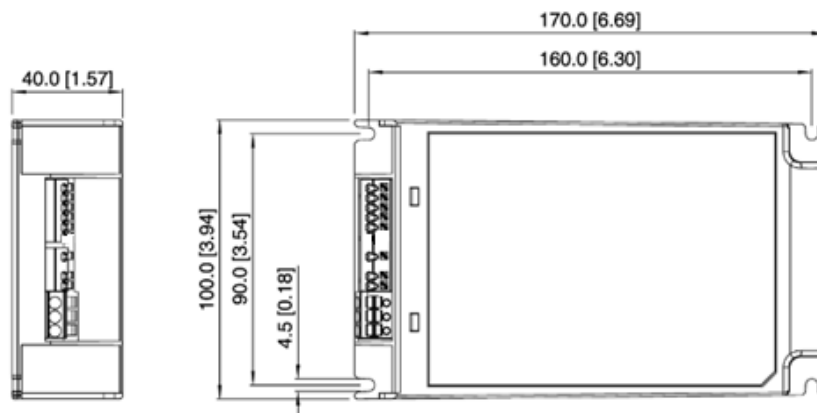

Unit: mm [inch]

LED Driver

EUCI LITE Series

Functions

Push DIM

Push DIM offer an alternative group dimming control method without DALI Controller, one or multiple push button can be used as dimmer and connect to one or multiple EUCI Lite driver(s) as illustrated below

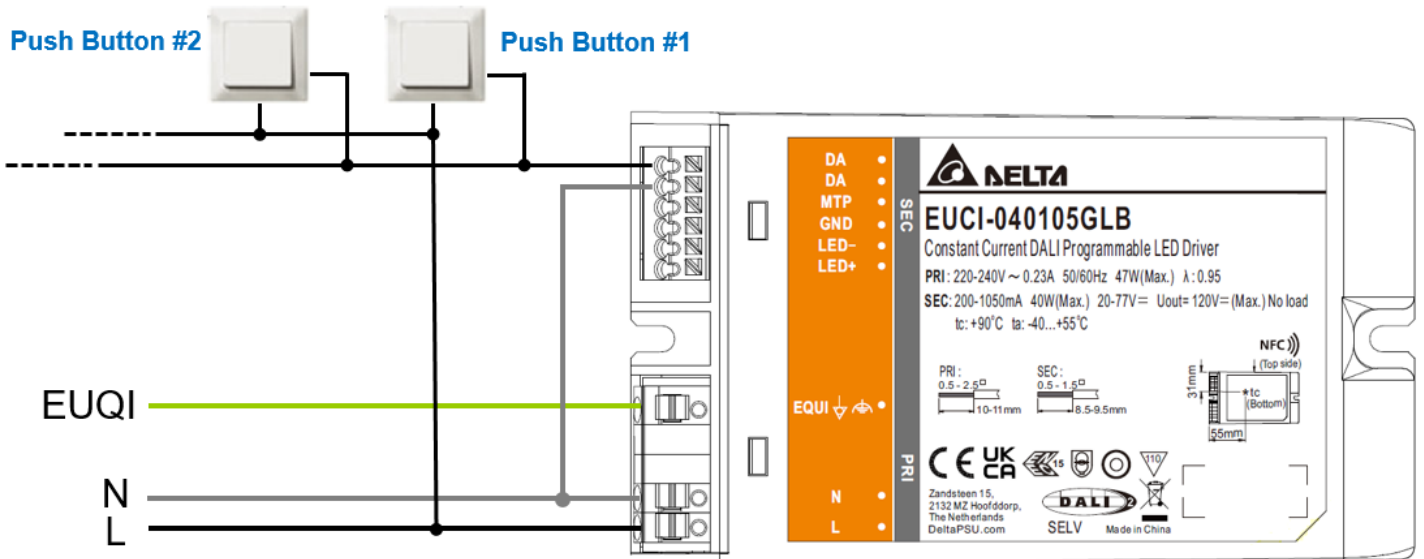

Push DIM operations are summarized as the table below,

Push DIM function	Contact duration	Dimming function
Ignore	< 60 ms	Ignore push
Short push	> = 60 ms and < 600 ms	Toggle the LED output ON/OFF
Long push	>= 600 ms	Dim the LED output up or down
Synchronize drivers	Long push -> short push -> long push	All drivers dimming level synchronize with each other

LED Driver

EUCI LITE Series

Corridor Mode

Similar to Push Dim Corridor Mode is operated without DALI controller, the LED output is adjusted to a defined level when a presence sensor detects a movement object in the range then hold at define level for a certain time before go to a defined background level when presence sensor is released as the movement object is no longer in the detection range. The operation is illustrated as shown below

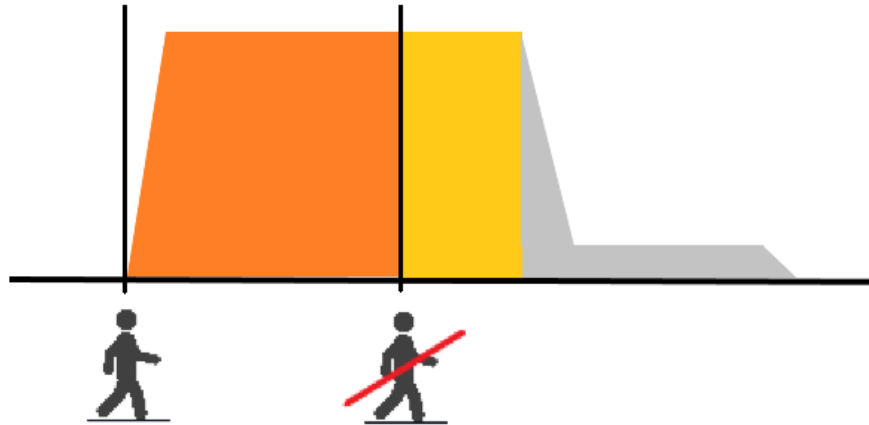

Smart Timer Dim

Provides three operation modes: Fixed Timer, Midnight Centric Timer, Ratio Rescale Timer.

Fixed Timer

It is a memoryless-based dimming mode that tracks the output level based on the programmed timing curve. The output level is organized by scheduled profile in five steps.

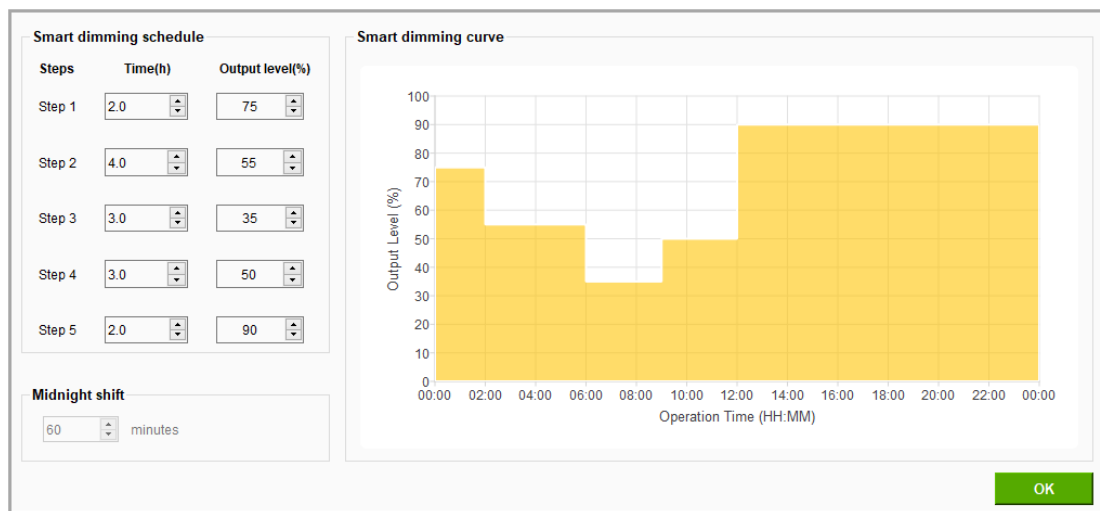

LED Driver

EUCI LITE Series

Midnight Centric Timer

This mode is a memory-based that automatically measures over the past two days the power-on time of the lighting installation at which is the naturally corresponded to night time. The Midnight Centric Timer software calculates the length of power on time and centralized from the given virtual midnight point and change the output level accordingly. More specifically, when the LED driver is power-on during the very first two days or the power-on time difference of past two days is more than 15 minutes, the output current will fixed to the maximum level since there is no valid (reasonable) data for reference. Start from the third day and so on, when the power-on time difference of past two days is less than 15 minutes, the output level is controlled based on the correlation between the midnight point of programmed profile and yesterday power-on duration.

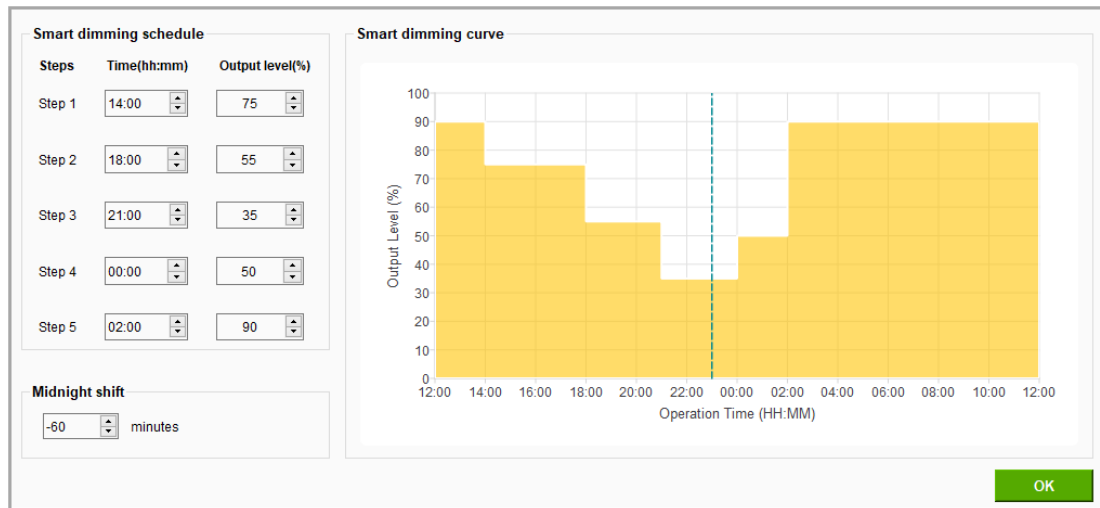

Ratio Rescale Timer

This mode is similar to Midnight Centric Timer that records the power-on time based on the local night time. The Ratio Rescale Timer software rescale programmed output power profile of each step by a calculated percentage of the recorded power-on time (when valid) out of given 5 steps duration.

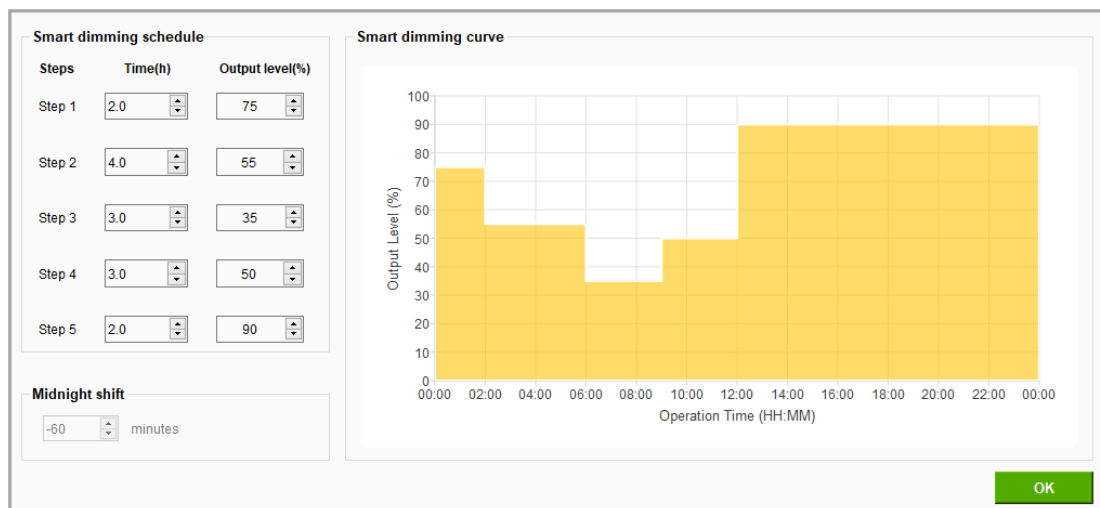

LED Driver

EUCI LITE Series

Override

When driver operate in Smart Timer Dim, the output will to be force to maximum level at any given time when AC mains are shorted to DALI port and by default driver will ignore the incoming DALI dimming command. Nevertheless, override by DALI dimming is possible by enable the override function in GUI. In this case, as soon as the driver received the DALI dimming command the operation will change from Smart Timer Dim to DALI mode until the AC power off. In the next AC power on, the driver will operate based on Smart Timer Dim again.

Module Temperature Protection (for LED module)

In the LED luminaire system application, user can enable the MTP function by GUI and be taken to place the NTC thermistor close to the hottest spot on the LED module to avoid the abnormal high temperature on LED module. If LED thermal protection is not required the NTC wire of the LED driver can be left open. The de-rating limits can be programmed using the programming tool. (NTC thermistor range 0.2~50Kohm)

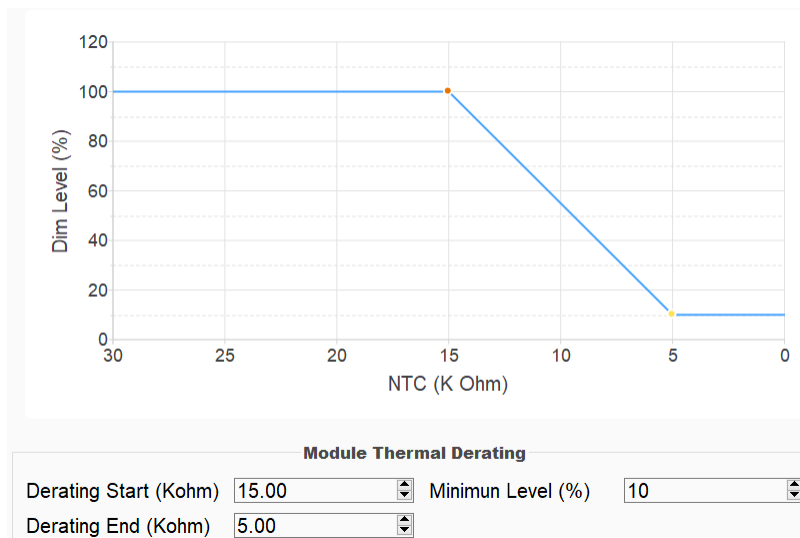

Start-up Time

The time required for the output voltage to reach 90% of its final steady state set value, after the input voltage is applied.

Rise Time

The time required for the output voltage to change from 10% to 90% of its final steady state set value.

Hold-up Time

Time between the collapse of the AC input voltage, and the output falling to 95% of its steady state set value.

■ Graph illustrating the Start-up Time, Rise Time, and Hold-up Time

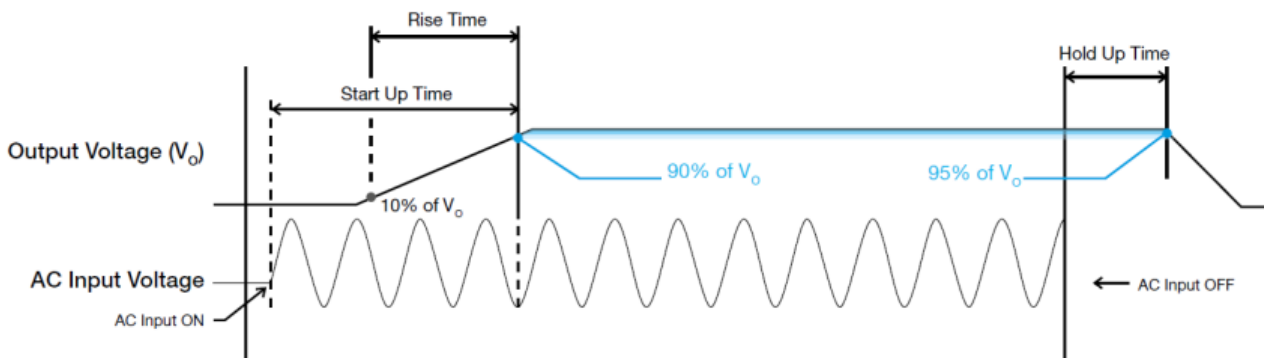

LED Driver

EUCI LITE Series

Inrush Current

Inrush current is the peak, instantaneous, input current measured and, occurs when the input voltage is first applied. For AC input voltages, the maximum peak value of inrush current will occur during the first half cycle of the applied AC voltage. This peak value decreases exponentially during subsequent cycles of AC voltage.

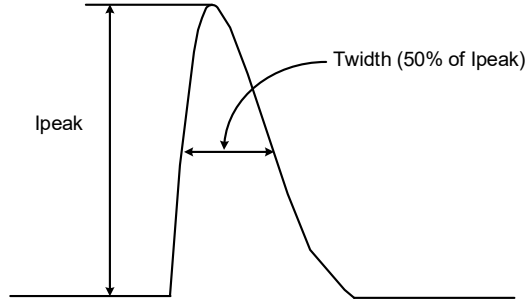

Wired Connection programming (Programmer tool SDDV1505UAC) or NFC programming.

EUCI-022105GLB / EUCI-040105GLB / EUCI-075105GB

EUCI-130105GLB / EUCI-170105GLB

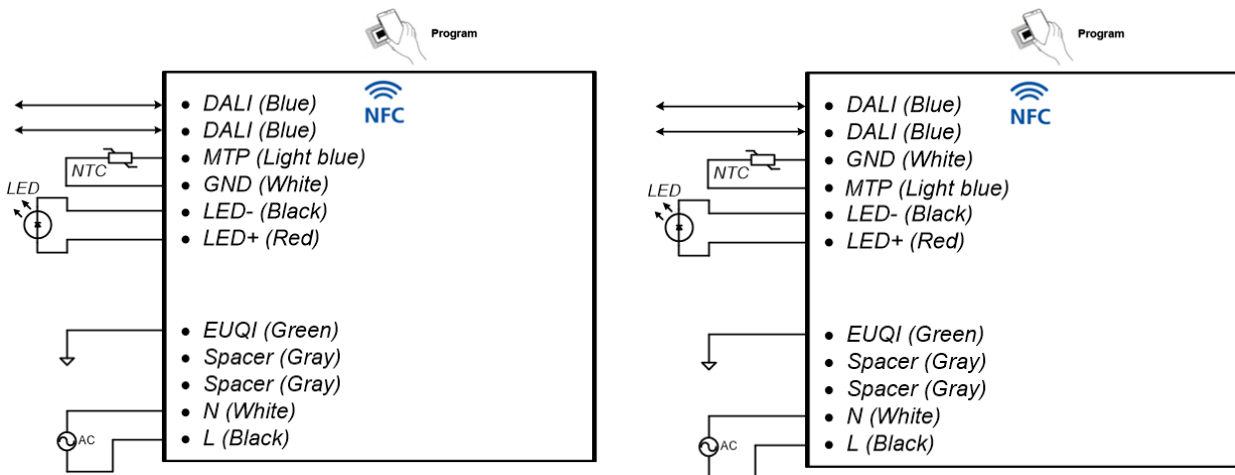

Others and Protection

Delta RoHS Compliant



Restriction of the usage of hazardous substances

The European directive 2011/65/EU limits the maximum impurity level of homogeneous materials such as lead, mercury, cadmium, chrome, polybrominated flame retardants PBB and PBDE for the use in electrical and electronic equipment. RoHS is the abbreviation for "Restriction of the use of certain hazardous substances in electrical and electronic equipment".

This product conforms to this standard.

PFC – Norm EN 61000-3-2

Line Current Harmonic content



Typically, the input current waveform is not sinusoidal due to the periodical peak charging of the input capacitor. In industrial environment, complying with EN 61000-3-2 is only necessary under special conditions. Complying with this standard can have some technical drawbacks, such as lower efficiency as well as some commercial aspects such as higher purchasing costs. Frequently, the user does not profit from fulfilling this standard, therefore, it is important to know whether it is mandatory to meet this standard for a specific application.

LED Driver

EUCI LITE Series

Over Voltage Protections (Auto-Recovery)

The LED driver's Overvoltage Protections (OVP) will be activated when output voltage is achieved trigger point defined at OVP range. Upon such an occurrence, the I_o (output current) will start to droop.

Short Circuit Protection (Auto-Recovery)

The LED driver's output OLP function also provides protection against short circuits. When a short circuit is applied, the LED driver will operate in "hiccup mode". It will return to normal operation after the short circuit is removed.

Overload & Overcurrent Protection (Auto-Recovery)

The LED driver's Overload (OLP) and Overcurrent (OCP) Protections will be activated when output is between 95% and 108% of I_o (max load). Upon such an occurrence, the V_o (output voltage) will start to droop. Once the LED driver has reached its maximum power limit, the protection will be activated; and, the LED driver will operate in "CC mode". The LED driver will recover once the fault condition once the cause of OLP or OCP is removed, and I_o is back within the specified range.

Over Temperature Protection (Auto-Recovery)

As mentioned above, the LED driver also has Over Temperature Protection (OTP). In the event of a higher operating temperature at 100% load, the LED driver will run into OTP when the operating temperature is beyond what is recommended in the de-rating graph. When activated, the output voltage will go into bouncing mode until the temperature drops to its normal operating temperature as recommended in the de-rating graph.

Safety Instructions

- ALWAYS switch mains of input power OFF before connecting and disconnecting the input voltage to the device. If mains is not turned OFF, there is risk of explosion / severe damage.
- To guarantee sufficient convection cooling, keep a distance of 50mm above and lateral distance to other units.
- DO NOT insert any objects into the device.
- When the PE terminal is not connected, the device must be installed on a metal plate with PE connection.
- The current rating for the output cable must be rated higher than or equal to the output current of the power supply. Please refer to the product specifications.
- For device with dimming function, always ensure the dimming control is working properly. "Dimming 0-10V" shall be insulated from AC mains by reinforced insulation.

Others

Warranty Policy

Please reach out our [Warranty Policy](#) should you require any further clarification.