

Industrial AC-DC Power Supply

2500W with 5V/2A Standby / PMS-2K5 series



PLEASE READ AND FULLY UNDERSTAND THIS USER MANUAL BEFORE UNPACK AND INSTALL THE POWER SUPPLY

Table of Contents

1. General safety information	2
1.1 Safety instructions.....	3
1.2 Warning.....	4
2. General overview.....	5
2.1 General Description	5
2.2 Connections	6
2.3 Installation Instruction	9
3. Electrical Functions of Main output	12
3.1 Start-up timing.....	12
3.2 Rise Time.....	13
3.3 Hold up time	13
3.4 Protections	14
3.4.1 Over voltage protection (OVP).....	14
3.4.2 Over load and over current protection (OLP/OCP).....	14
3.4.3 Short circuit protection (SCP).....	14
3.4.4 Over temperature protection	14
3.4.5 Fan fault protection	14
3.5 Remote On_Off control	15
3.6 Power good signal.....	15
3.7 Remote Sense connection	16
3.8 Voltage Adjustment.....	17
3.9 Parallel operation	17
4. PMbus	18
5. Appendix A: I ² C Communication Specification for Standard Series Products	19

Industrial AC-DC Power Supply

2500W with 5V/2A Standby / PMS-2K5 series



Highlight & Features

- Up to 2500 Watt in 5"x10.67"x1.59" Package
- Up to 29.5W/inch³ Power Density
- Full Power from 180V to 264V
- Full Power up to 50°C Ambient
- Up to 500KHrs MTBF
- CC/CV Mode Selectable
- 5V/2A Standby Output
- Active Current Sharing
- Conformal Coating
- Class B Conducted and Radiated EMI
- Normal and Reversed Option for Remote On/Off and Power Good Signal
- Analog and Digital Voltage Trimming
- PMBus Ver 1.3 Supported
- Intelligent Fan Speed Control

1. General safety information

In the user manual, contains four kinds of safety tips: DANGER, WARNING, CAUTION and NOTE. Before reading this manual, you must have a fully understanding of these safety tips.

Safety tips are defined as follows:



If described event is unavoidable, it will cause serious physical injury or death to service engineer, operator, patient, or other personnel.



If described event is unavoidable, it will be occurred serious physical injury for service engineer, operator, patient or other personnel, or catastrophic damage for the power supply or any electronic devices connected to the power supply, or to lose important data or system operation chaos.



If described event is unavoidable, it will be occurred physical injury for service engineer, operator, patient or other personnel, or damage the power supply or any electronic devices connected to the power supply, or to lose data or system operation chaos.



If described event is unavoidable, it will be provided to alert relevant personnel who can contact with the power supply that serious injury will result if the hazard identified is ignored.

Industrial AC-DC Power Supply

2500W with 5V/2A Standby / PMS-2K5 series

1.1 Safety instructions

Installation:

Requirements of IEC/EN 62368-1 shall be observed during the installation in the final system. The products are intended for build in use in the final Class I system and to avoid risk of electric shock, products must only be connected to a supply mains with protective earth.

Servicing:

Instructions or reference information for repair of equipment parts are provided by the manufacturer. Please contact us for this information. Do not modify the product without authorization from Delta.

Critical Components:

These products are not authorized for use as critical components in nuclear control systems, life support systems or equipment for use in hazardous environments without the express written management approval from Delta.

Product Usage:

These products are designed to apply in medical, industrial, commercial and IT equipment which need to use DC voltages.

Environmental:

These products are IPX0, and therefore chemical/solvents, cleaning agents and other liquids must not be used. They shall be operated in dry locations to protect from moisture and are not suitable for using in an oxygen rich environment.

Environment:

This power supply is a switch mode power supply for use in applications within a Pollution Degree 2, overvoltage category II environment. Material Group IIIb PCB is used.

Input Parameters:

This product must be operated within the input parameters stated in the product limitations in this user manual.

Output Loading:

The power supply output power taken must not exceed the rating that is stated on label of the power supply, except as stated in the product limitations in this user manual.







End of Life Disposal:

The power supply contains components that require special disposal. The instructions shall be according to Directive 2012/19/EU of waste electrical and electronic equipment (WEEE) For end of life cycle, make sure that the power supply doesn't throw into general trash, and it must be handed over to the local recycle system.

Industrial AC-DC Power Supply

2500W with 5V/2A Standby / PMS-2K5 series

1.2 Warning

	<p>There's no practical design can incorporate protection for operators or service personnel who do not take adequate safety precautions. Only authorized, qualified, properly trained personnel and operating personnel are allowed to work with the power supply. The appropriate personnel must be aware of the inherent dangers / hazardous associated with the servicing of power supply contains hazardous high voltage.</p>
	<p>There are double pole/neutral fusing inside the power supply</p>
	<p>The power supply has sharp metal edge, pay attention to this before installation to avoid injury.</p>
	<p>It is the power supply user's responsibility to use and operate the power supply in proper way for functionality and safety. Although Delta Electronics provides information for the power supply and potential hazards, but Delta Electronics assumes no responsibility for use and operating the power supply after sale.</p> <p>Delta Electronics assumes no responsibility if the power supply is not installed according this manual.</p> <p>Delta Electronics assumes no responsibility if the power supply is not correctly maintained according this manual.</p> <p>Delta Electronics assumes no responsibility for any if the power supply is modified in any way after sale.</p>
	<p>It is not allowed to disassemble the power supply without Delta's technical support or authorization, to avoid the injury by high voltage.</p>
	<p>Please take all required preventive measures with related hazards if any cover must be removed. When the need of removal is completed, please replace the covers immediately.</p>
	<p>Hazardous voltage exists inside the power supply whenever the AC main power is connected to the power supply. Moreover, hazardous voltage will continue to exist even after the power supply is disconnected from the AC input voltage after a certain period of time. This hazardous voltage exists in but not limited to following parts: Fuse, Fuse holder, Main Relay, Bridge rectifier, Bulk Capacitors, Main Power Circuits, Associated circuits on power input board, etc.</p> <p>Although bleeding resistors are added for energy stored capacitor to discharge after AC off, due to the possibility of component fault, the bleeding functionality may not work. Calibrated measurement equipment, for example, voltage meter, must be used to measure voltage to confirm it is within safe voltage range before access the parts.</p>

Industrial AC-DC Power Supply

2500W with 5V/2A Standby / PMS-2K5 series

2. General overview

2.1 General Description

The PMS-2K5 series of internal built power supplies come with universal AC input range from 85Vac to 264Vac. Other features include low leakage. The PMS-2K5 series is certified for EMC standards according to EN 55032 for Industrial Technology Equipment (ITE) radio-frequency equipment. In addition, only recognized Japanese capacitors are used to ensure long product life.

The PMS-2K5 series comes with ITE safety approvals, including UL/CE/CQC (5000 meters), and CB certification. Designs are compliant with RoHS Directive 2011/65/EU for environmental protection, to avoid risk of opening of a branch circuit breaker, the product is tested on a 50A branch circuit, if used on a different branch circuit, additional testing may be necessary.

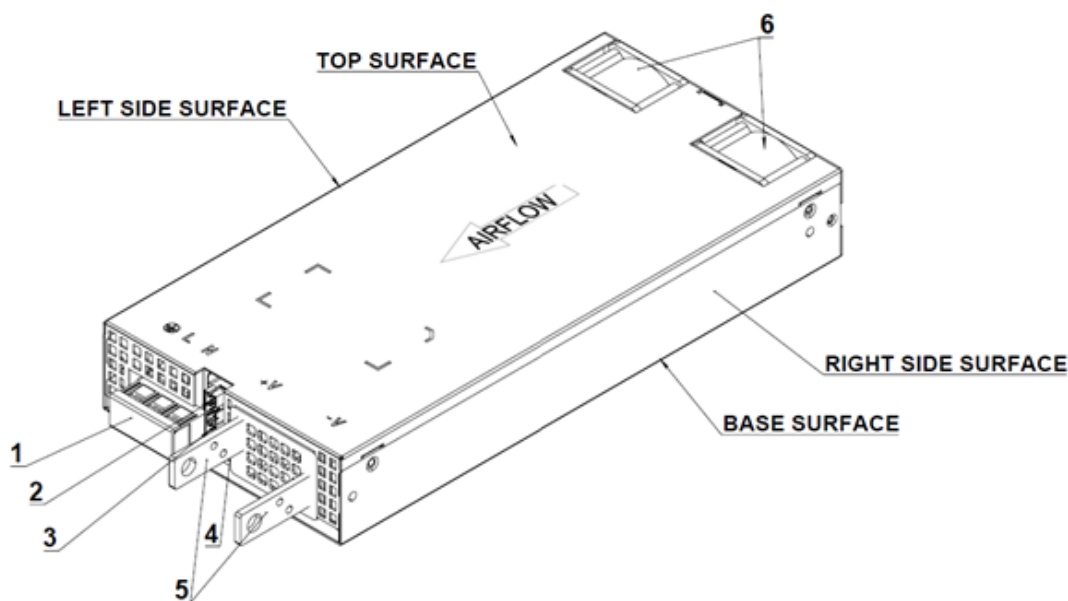

Fig. 1: Components of the PMS-2K5A series

1. AC/DC input terminal block (CN1)
2. Signal connector and Auxiliary DC Output (CN605)
3. Signal connector and Auxiliary DC Output (CN602)
4. Output voltage adjustment potentiometer
5. DC output terminal (CN101)
6. Fans

Industrial AC-DC Power Supply

2500W with 5V/2A Standby / PMS-2K5 series

2.2 Connections

AC/DC input terminal block (CN1)

CN1 is the input connector, a standard screw type 3-pin connector with clamp washer and a terminal centres pitch distance of 9.5 mm (0.37 in).

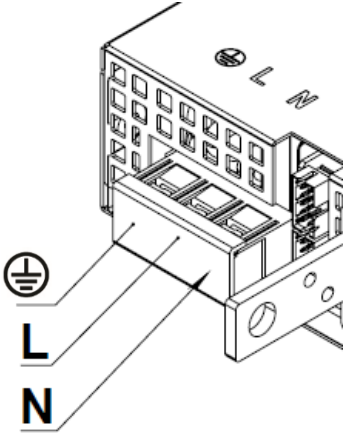

Pin	Assignment
L	Line (Phase)
N	Neutral
	Ground/Earth

Wire range: 12-18 AWG
 Screw torque: 0.59-0.69N.m (5.21-6.08 lb-in)
 Screws are suitable for slotted and Phillips head screwdrivers.

Fig. 2: AC/DC Input terminal block (CN1) – pin assignment

Table 1: AC/DC input terminal block (CN1) - pin assignment

Signal connector and Auxiliary DC Output (CN605)

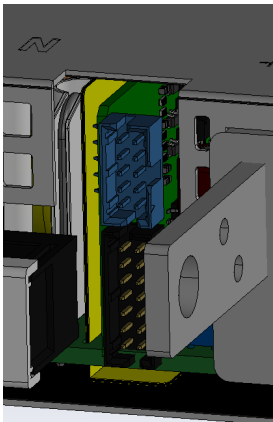

Fig. 3: Signal port and Auxiliary DC Output (CN605)

Fig. 4: Signal port and Auxiliary DC Output (CN605)

Control Connector CN605(Molex:87833-1025) Mating With Molex:51110-1051 Terminal:0503948052			
Pin 1	5V bus for I ² C	Pin 6	NC
Pin 2	DC RTN of 5V bus for I ² C	Pin 7	Address bit 0 (A0)
Pin 3	Serial data signal (SDA)	Pin 8	Address bit 1 (A1)
Pin 4	Serial clock signal (SCL)	Pin 9	Address bit 2 (A2)
Pin 5	NC	Pin 10	NC

Table 2: Signal port and Auxiliary DC Output (CN605) – Pin assignment

Industrial AC-DC Power Supply

2500W with 5V/2A Standby / PMS-2K5 series

Signal connector and Auxiliary DC output (CN602)

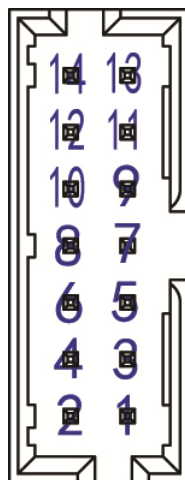
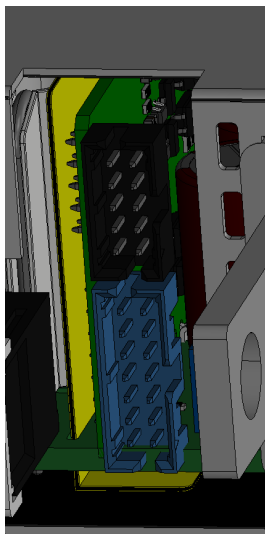

Fig. 5: Signal port and Auxiliary DC Output (CN602)

Fig. 6: Signal port and Auxiliary DC Output (CN602) – Pin assignment

Control Connector CN602 (Molex: 87833-5321) Mating With Molex: 51110-1451 Terminal: 0503948052	
Pin 1	Remote On Off/Inhibit +
Pin 2	Remote On Off/Inhibit -
Pin 3	Power Good-
Pin 4	Power Good+
Pin 5	NC
Pin 6	NC
Pin 7	5V Standby Output +
Pin 8	5V Standby Output +
Pin 9	DC RTN
Pin 10	DC RTN
Pin 11	Remote Sense +
Pin 12	Remote Sense -
Pin 13	Current Share
Pin 14	CC/CV mode switch

Table 3: Signal port and Auxiliary DC Output (CN602) – Pin assignment

Industrial AC-DC Power Supply

2500W with 5V/2A Standby / PMS-2K5 series

Output voltage adjustment potentiometer

The Output voltage adjustment potentiometer is for output voltage adjustment within the range of specifications.

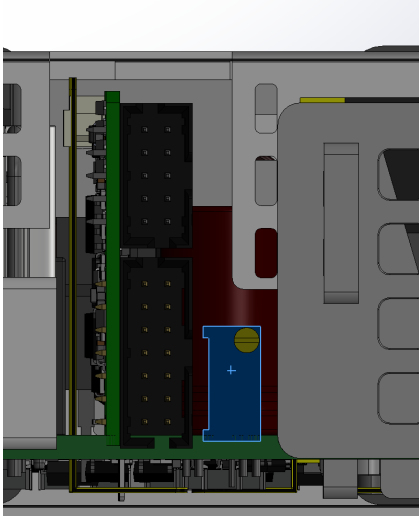
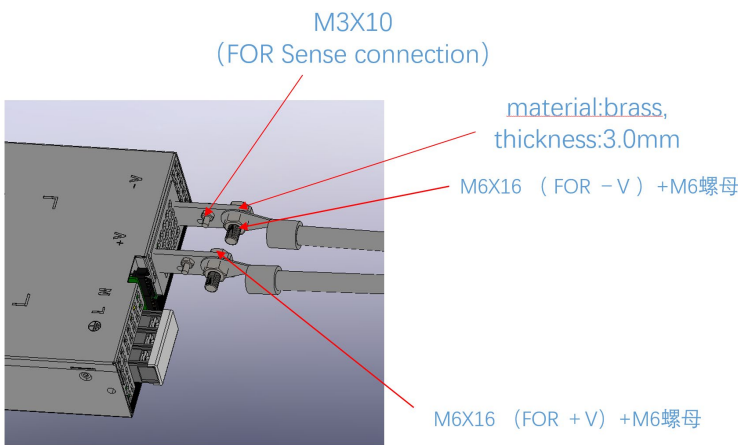

Fig. 7: Output voltage adjustment potentiometer

Main DC output terminal (CN101)



Pin	Assignment
+V	Main Output+
-V	Main DC Return

Wire range: 4-12 AWG
 Screw torque: 3.14N.m (27.81 lb-in)
 Screws are suitable for slotted and Phillips head screwdrivers.

Table 4: DC output port (CN101)-pin assignment

Fig. 8: Main DC Output terminal (CN101) – pin assignment

Current Rating for PVC Wire AWG			
1/0 AWG	211.12 A	18 AWG	9.0 A
2 AWG	132 A	20 AWG	6.5 A
4 AWG	83.4 A	22 AWG	5.0 A
10 AWG	29.0 A	24 AWG	3.5 A
12 AWG	22.5 A	26 AWG	2.5 A
14 AWG	16.5 A	28 AWG	2.0 A
16 AWG	12.0 A	30 AWG	1.5A

Industrial AC-DC Power Supply

2500W with 5V/2A Standby / PMS-2K5 series

2.3 Installation Instruction

The Installer Requirement:

- Must have necessary electric knowledge and understand the risks of electric shock;
- Must read the safety warning from section 1.1-1.2 carefully
- Must fully understand the connections in 2.2 before installation.

Mounting orientations



Fig. 9: Standard mounting orientation

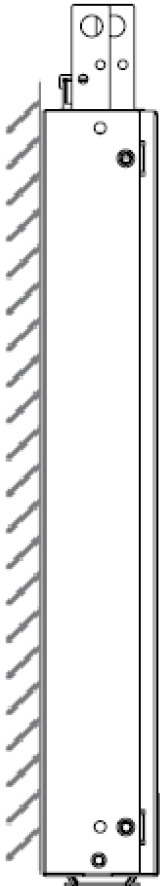

Fig.10: Vertical mounting

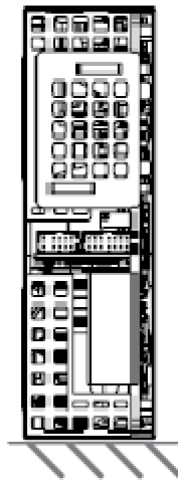

Fig. 11: Mounting on the right side

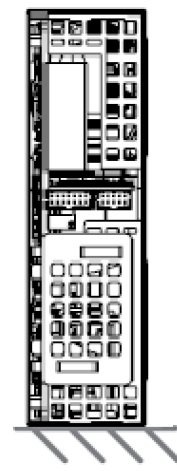

Fig. 12: Mounting on the left side

Industrial AC-DC Power Supply

2500W with 5V/2A Standby / PMS-2K5 series

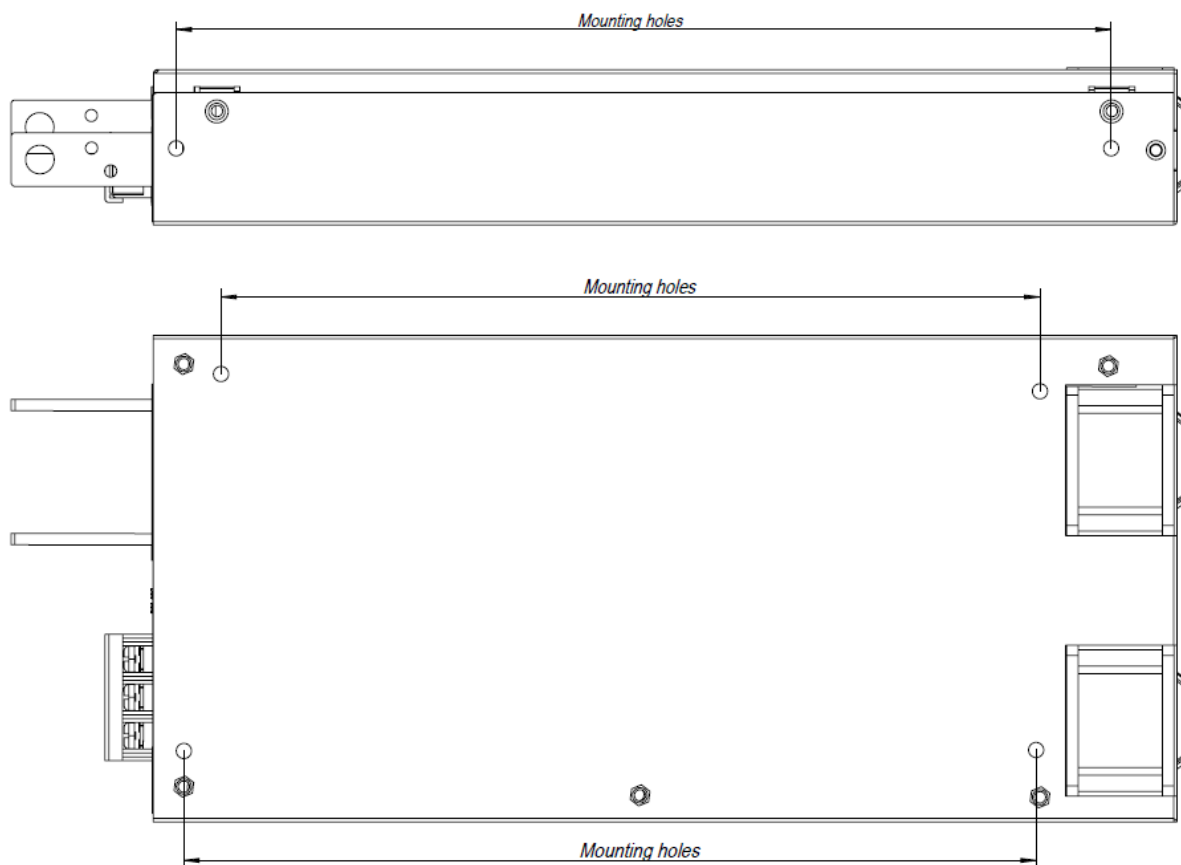

Fig. 13: Position of mounting holes

Note: Always keep ≥ 20 mm (0.79 in) space on the fan side and on the connector side to ensure proper airflow.

Industrial AC-DC Power Supply

2500W with 5V/2A Standby / PMS-2K5 series

Dimensional drawings

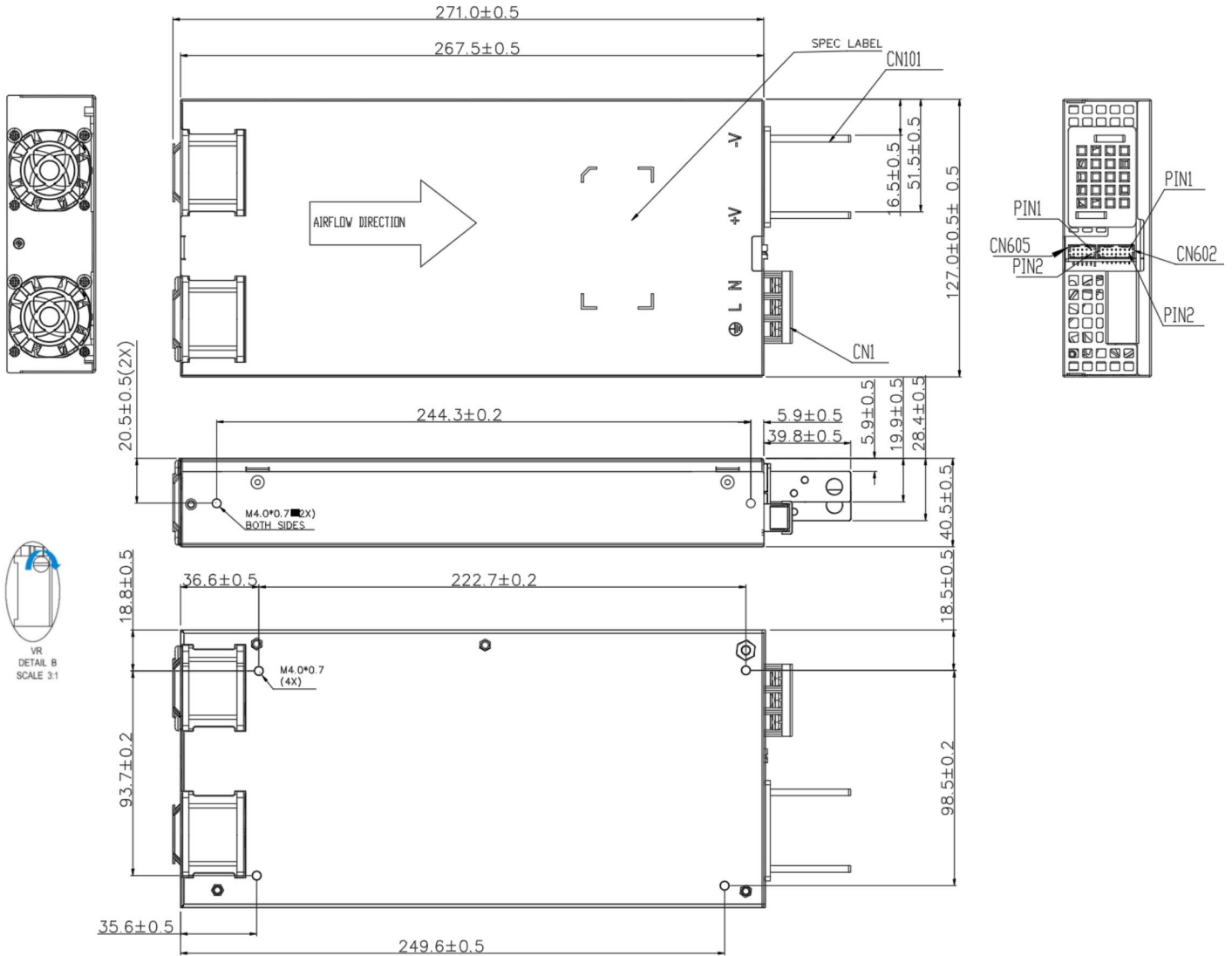

Fig. 14: Dimensional drawing PMS-2K5A

Note:

1. Base plate mounting, M4 thread holes, maximum penetration 3.0 mm (0.118 inch) from outside face of chassis, maximum torque 9-10 kgf.cm (7.82-8.69 lbf.in).
2. Side mounting, M4 thread holes, maximum penetration 3.0 mm (0.118 inch) from outside face of chassis, maximum torque 9-10 kgf.cm (7.82-8.69 lbf.in).
3. CN101, M6 screw in two positions, maximum torque 32 kgf.cm (27.81 inch.lbs). M3 screw in two positions, maximum torque 4-5 kgf.cm (3.48-4.35 inch.lbs)
4. CN1, M3.5 screw in three positions, maximum torque 6-7 kgf.cm (5.21-6.08 inch.lbs).
5. VR: clockwise is to increase the output voltage, anti-clockwise is to reduce the output voltage in voltage mode, and to change current in current mode.
6. All dimensions are in millimeters and inches.

Industrial AC-DC Power Supply

2500W with 5V/2A Standby / PMS-2K5 series

3. Electrical Functions of Main output

3.1 Start-up timing

Start-up time is defined as the time duration from when the AC is applied with remote on off signal enabled to the output voltage reaching to higher than 90% of its final steady value. PMS-2K5 series power supply can provide 2s max start up time to meet the fast power up requirement.

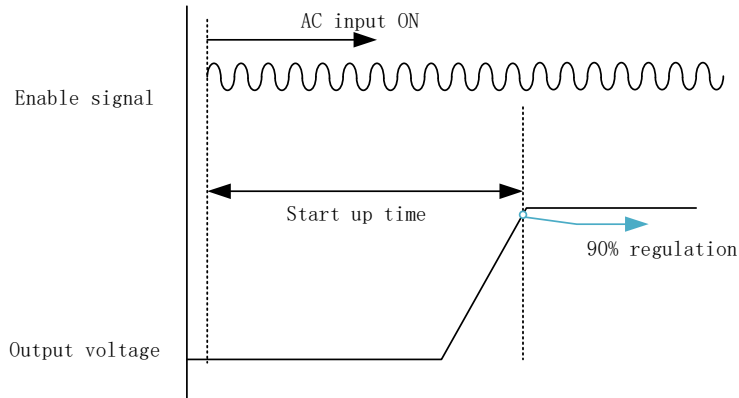

Fig. 15: Start-up timing sequence

The standard product sets the remote on off signal to be enabled as default, if customer is choosing the reverse logic version, then remote on off signal is required to be enabled before powering up the power supply, otherwise the startup time is determined by the time when the remote on off signal is set to be enable.

When the power supply is originally disabled and then enabled by the remote on_off control signal, the enable time is 100ms max, this includes the output rise time to 90% regulation.

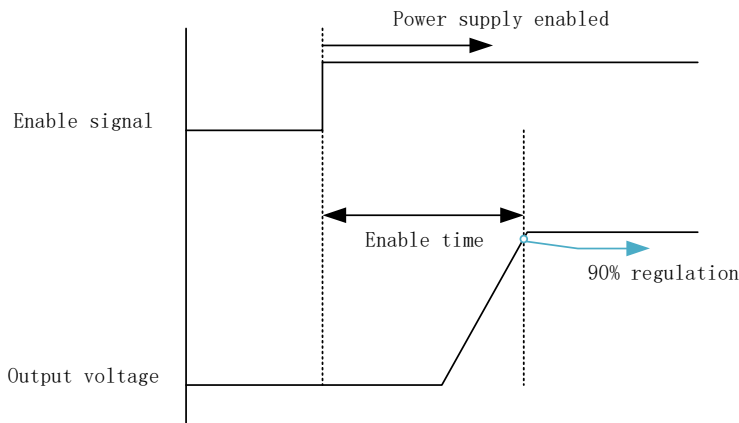

Fig. 16: Enable timing sequence

Industrial AC-DC Power Supply

2500W with 5V/2A Standby / PMS-2K5 series

3.2 Rise Time

Rise time is defined as the time from when the output voltage is higher than 10% regulation voltage to the point when the output voltage reaches 90% output regulation level. The rise time provided by PMS-2K5 series is 50ms max.

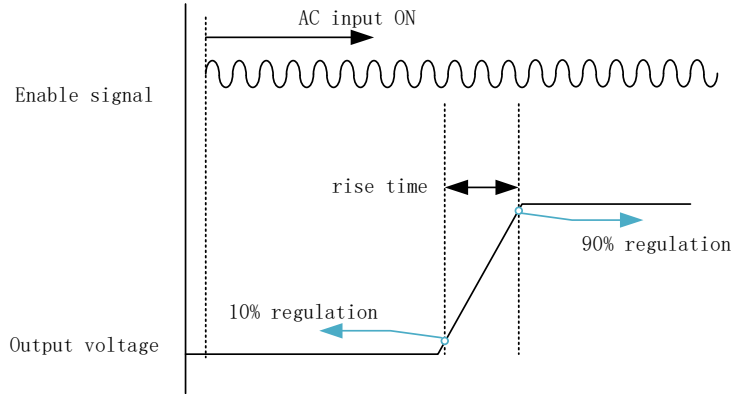

Fig. 17: Rise time sequence

3.3 Hold up time

Hold up time provide the system the necessary back up time from when AC is collapsed to the output voltage falls below 90% regulation value. As when AC input is off, it is depending on the internal power reserved in the power supply to support the output power, different output level will bring different hold time. PMS-2K5 series defines the hold time with 2000W load @230V, the hold time can be 16ms min.

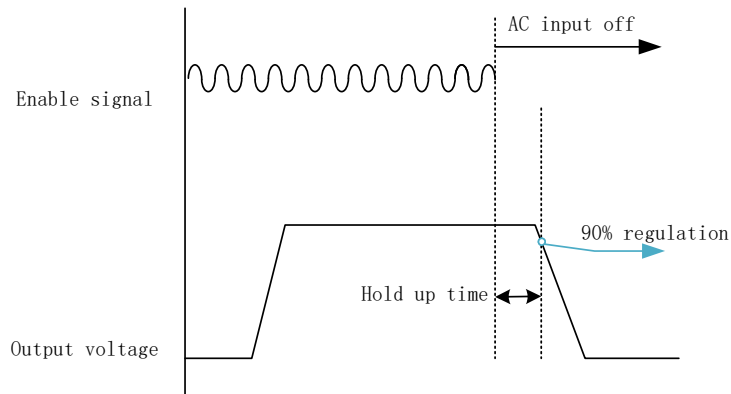

Fig. 18: Hold up time sequence

Industrial AC-DC Power Supply

2500W with 5V/2A Standby / PMS-2K5 series

3.4 Protections

3.4.1 Over voltage protection (OVP)

When the output voltage sees unusual high peak or the internal feedback control loop fails to lead the output voltage to be unusually high, power supply can sense the output voltage, if the output voltage is higher than certain limit (145% regulation max), the power converter will be disabled with latch mode, two ways can clear the latch fault. One is by removal and re-application of the AC input voltage, the other is to toggle the remote on off signal. If the protection is not cleared, power supply will stay protected.

3.4.2 Over load OLP

The power supply's Overload (OLP) Protections will be activated when output current exceeds 130% of IO (Max load). In such occurrence, the VO will start to droop and once the power supply has reached its maximum power limit, the protection is activated and the power supply will go into "Hiccup mode" (Auto-Recovery). The power supply will recover once the fault condition of the OLP is removed and IO is back within the specifications.

Please be noted the output current might be clamped in constant current mode and in this case, the protection will be triggered by output under voltage.(85% for 24V and 82% for 48V)

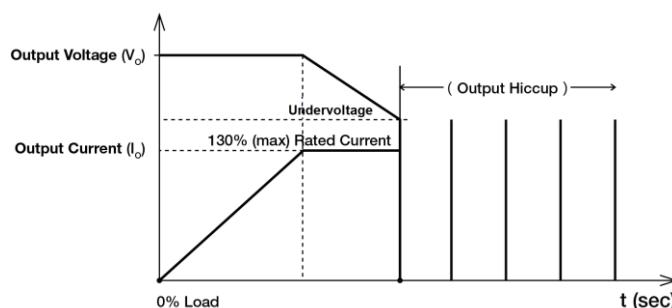

Fig. 19: Auto restart hiccup during OLP/OCP

Additionally, if the Iout is >100% for a prolonged period of time (depending on the load), the Over Temperature Protection (OTP) may be activated due to high temperature on critical components. The power supply will then go into recovery mode.

3.4.3 Short circuit protection (SCP)

Output OLP/OCP function also provides protection against short circuits. When a short circuit is applied, the output current will operate in "Hiccup mode", The power supply will return to normal operation after the short circuit is removed.

3.4.4 Over temperature protection

As mentioned above, the power supply also has Over Temperature Protection (OTP). This is activated when the overload condition persists for an extended duration and the output current is below the overload trigger point but >100% load. In the event of a higher operating temperature condition at 100% load, the power supply will run into OTP when the surrounding air temperature is higher than the operating temperature. When activated, the output voltage will go into recovery mode until the surrounding air temperature drops to its normal operating temperature.

3.4.5 Fan fault protection

PMS-2K5 is embedded with fans and intelligent fan speed control, the fans are essential to achieve 2500W high power output without getting overheated, and the product can protect itself from detecting the fault of the fans. If the fans are not functioning properly for longer than 50 seconds, then the controller will consider there is potential risk for the power supply to get overheated and shut down the converter with latch mode, again to successfully restart the power supply, customer needs to remove all the fault condition that might cause the fan fault and use AC input or remote on off signal to enable the output voltage again.

3.4.6 Under voltage protection (UVP)

When the output current exceeds a certain value of rated current, the output current will be clamped to be constant (<130% rated current), output voltage will then drop if output impedance keeps decreasing in the constant current control. Finally output under voltage protection will be triggered if the output voltage falls below (85% for 24V and 82% for 48V) rated value, and the power supply will be disabled with Hiccup mode (Auto-Recovery). The power supply will recover once the fault condition of the OLP and OCP is removed and IO is back within the specifications.

Industrial AC-DC Power Supply

2500W with 5V/2A Standby / PMS-2K5 series

3.5 Remote On Off control

Remote On off control allows customer to easily control the power supply from system level point of view, PMS-2K5 series uses an isolated diode located within the power supply. The remote control signal can be used to enable or disable only the main output. When the main output is disabled, the +5V Standby output will continue to operate.

Below is a suggested connection to use the remote on off signal, system can use a switch to conduct through this diode (suggested pull up resistor to 5V standby with 500~1Kohm resistor) to disable the main out. The signal can be floated (no connection to the signal), in order to enable the main output

It is easily to know that conduct the diode to disable the power supply and left the diode to be open to enable the output, so customer can design its own control circuit to use this signal to realize different logic control.

If customer wants a reversed control logic of the diode to enable/disable the output, please consult with Delta.

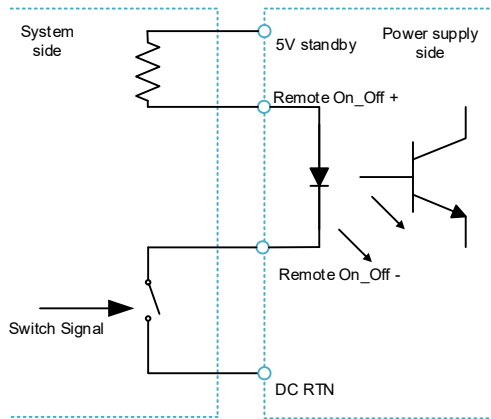

Fig. 20: Remote On off connection

3.6 Power good signal

Power Good+/- pin is an isolated open collector transistor (80V/50mA rating). A resistor (suggested value 10Kohm, 1/8W) can be added between Power Good- pin and DC RTN, Power Good+ pin can be connected to 5V standby (or, other available pull-up voltage that is no greater than the transistor rating). Value of resistor may have to be adjusted, depending on voltage used, and other end-use conditions of the Power Good+ pin connection to the product.

The Power Good- with the DC RTN as the reference is the Power Good Signal (Shown in below figure).

When AC input is on and main output voltage $\geq 0.83V_{set}$ with 200ms delay time, Power Good Signal (Shown in below figure) generated will be high. When AC input is off, Power Good Signal generated will be low. Power Good Signal generated will also be low when remote off or under single fault operating condition, Fan abnormality, UVP, OVP, OTP.

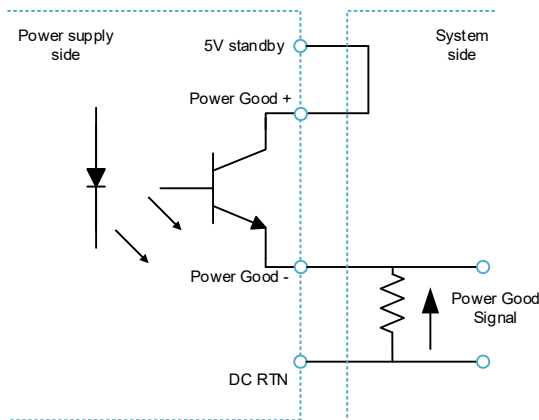

Fig. 21: Power good signal connection

Industrial AC-DC Power Supply

2500W with 5V/2A Standby / PMS-2K5 series

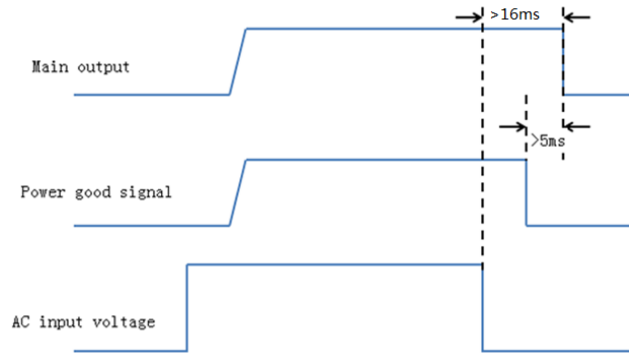

Fig. 22: Power good signal sequence

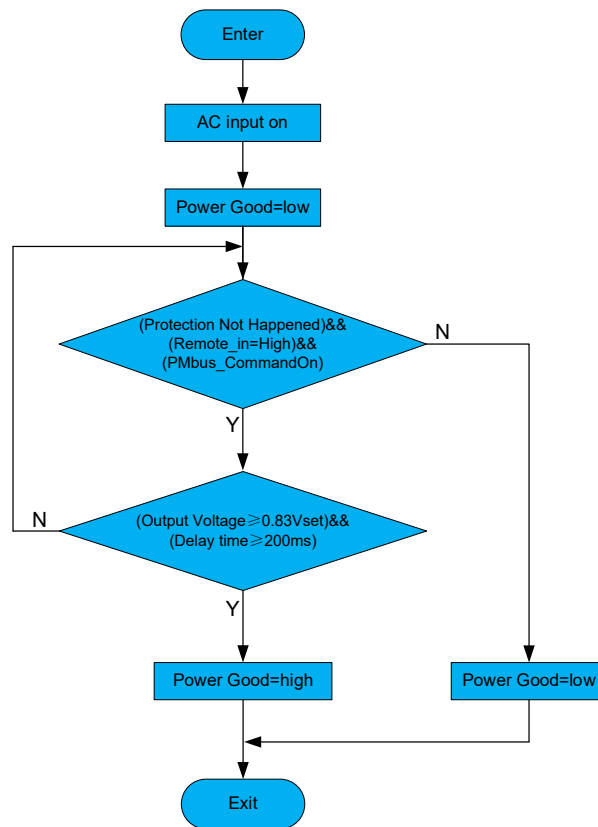

Fig. 23: Program Flow Diagram of Power Good

3.7 Remote Sense connection

Remote sense feature can be used to compensate for the extra voltage drop on output wires that are connected from the main output terminals, to the load. With wires connected from the remote sense pins, at the same locations as the wires from the main output.

Note that line drop (voltage drop due to wiring) compensation voltage range must be such that the output voltage is

within the output voltage adjustment range and that the voltage to compensate must be within 0.5V (in the connection picture, $V_o - V_{o_load}$ must be less than 0.5V, or $DC_RTN_load - DC_RTN$ be less than 0.5V).

Consider power loss due to line drop and use this unit within the maximum allowable output power. Reduce the effect of noise induced into the remote sensing lines by using shielded lines, a twist pair, or a parallel pattern, etc.

PMS-2K5 also provides the protection mode if the remote sense wire connection is fault made, the power supply will not be damaged if the remote sense pins are shorted, or if a reverse/inverted polarity connection is made to the load, this gives more reliable operation in

Industrial AC-DC Power Supply

2500W with 5V/2A Standby / PMS-2K5 series

real application. To be noted, if misconnect the remote sense wires, the power supply will be protected and can not normally operate, please check the wire connection carefully before power up the product in this case.

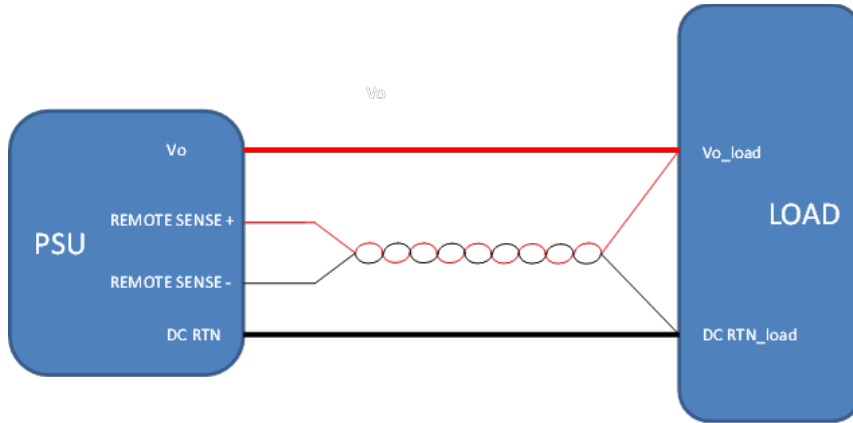

Fig. 24: Remote sense connection

3.8 Voltage Adjustment

The power supply provides a potentiometer for user to adjust the output voltage. The output voltage is designed to be able to adjust up to +16% of rated voltage, when the output is adjusted below nominal value, the maximum output current is the same as the nominal output, when the output is adjusted above nominal value, the output power cannot exceed the nominal maximum power (the maximum output current will be reduced accordingly).

3.9 Parallel operation

PMS-2K5 series has an active current sharing circuit for the main output; it can realize the output current to be balanced when customer is using two or more power supplies in parallel to achieve higher output power.

A one wire current share bus is used to achieve current sharing between units, the current share bus must be connected together among different units (pin 13 of CN602, refer to power supply structure and pin assignment in section 2.2).

The difference in output voltage can impact the current sharing accuracy, all the units to be paralleled, please use the voltage adjustment function to set the voltage to be ± 50 mV of the set value.

The paralleled units can be connected with or without remote sense function, below is a typical connection of the parallel connection.

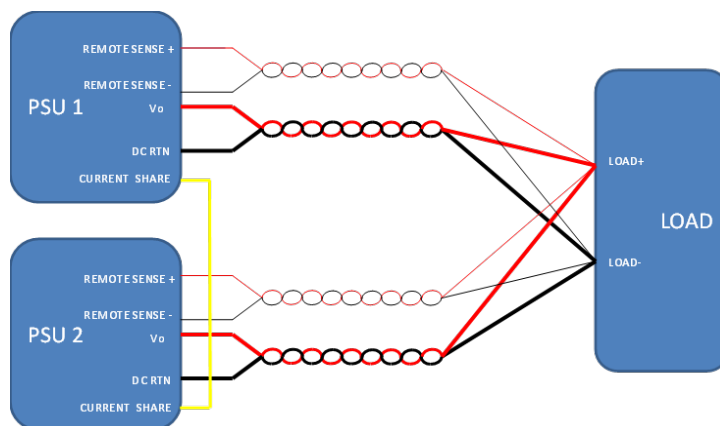

Fig. 25: parallel connection with remote sense

Industrial AC-DC Power Supply

2500W with 5V/2A Standby / PMS-2K5 series

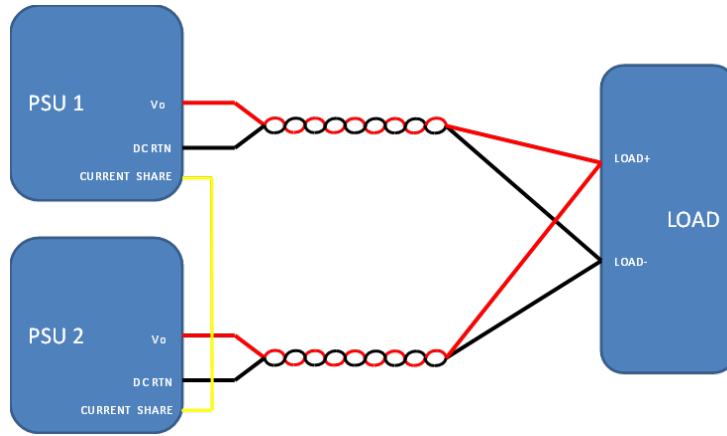

Fig. 26: parallel connection without remote sense

An Or-ing circuit is needed to form a redundant connection, if in system application more than 2pcs power supplies need to be paralleled, please contact Delta for technical support.

4. PMbus

Please refer to "I2C Communication Specification for Standard Series Products" in Appendix A.

I2C communication pins PMBUS_CLK and PMBUS_DATA are internal pull-up by 5.1Kohm resistor to 5.0V standby. The internal and external total pull-up resistor shall be between 4.7Kohm and 100Kohm, customer shall verify the external pull-up resistor in system side.

The MEP-PMB series interface adapter is designed for converting I2C communication protocol used in Delta standard industry and medical power supply unit to other interface, including USB, RS485, RS232. An on board address switch can configure up to 8 address in one bus. Below is the three adaptors and the assembly with PSU.

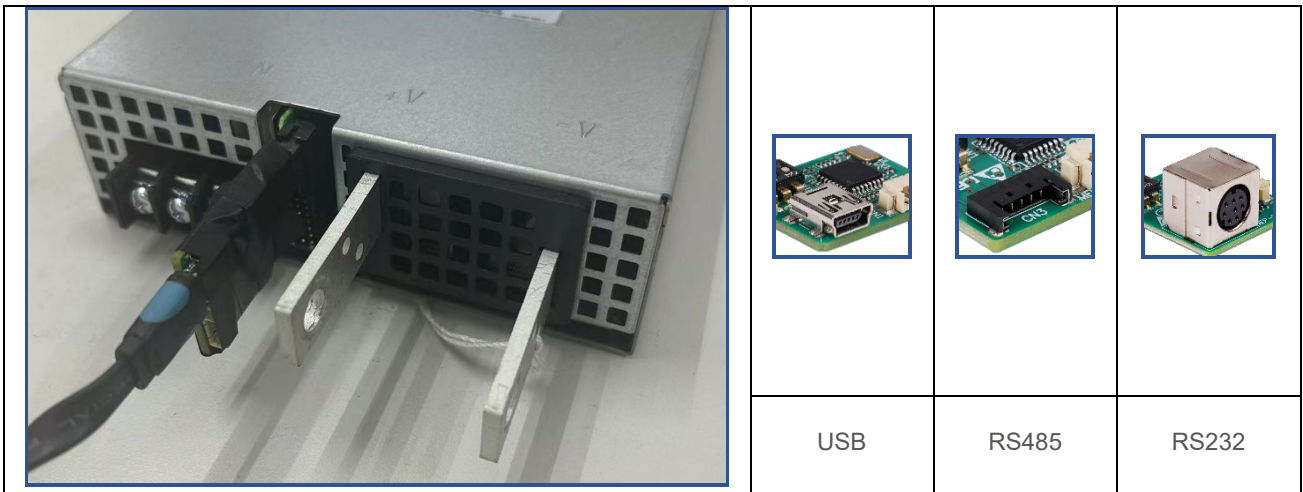

Industrial AC-DC Power Supply

2500W with 5V/2A Standby / PMS-2K5 series

Appendix A: I²C Communication Specification for Standard Series Products

Table of Contents

1. Overview	21
1.1 Introduction.....	21
1.2 Referenced Standards.....	21
1.3 Acronyms and Definitions	21
2. Protocol Descriptions.....	21
2.1 Communication Topology	21
2.2 Communication Signal.....	21
2.3 Address Selection.....	22
2.4 Command Structure.....	22
3. Command List	24
4. Reporting Command	26
4.1 Report Vout Mode.....	26
4.2 Report Vout Command	27
4.3 Report Vout Max.....	27
4.4 Report Vout Min.....	27
4.5 Report Coefficients	28
4.6 Report Fan Configuration	29
4.7 Report Fan Command	29
4.8 Report OVP Fault Limit.....	30
4.9 Report OVP Fault Response	30
4.10 Report UVP Fault Limit.....	31
4.11 Report UVP Fault Response.....	31
4.12 Report OTP Fault Limit	31
4.13 Report OTP Fault Response.....	32
4.14 Report OPP Fault Limit.....	32
4.15 Report OPP Fault Response	33
4.16 Report Status Byte.....	33
4.17 Report Status Word	34
4.18 Report Vout Status	35
4.19 Report Iout Status.....	35
4.20 Report Temperature Status	36
4.21 Report CML Status	36
4.22 Report Manufacturer Specific Status	37
4.23 Report Fan Status.....	37
4.24 Report Output Voltage	38
4.25 Report Output Current	38
4.26 Report Temperature	38
4.27 Report Fan Speed	39
4.28 Report Output Power	39
4.29 Report PMBus Revision.....	39

Industrial AC-DC Power Supply

2500W with 5V/2A Standby / PMS-2K5 series

4.30	Report Manufacturer ID	40
4.31	Report Manufacturer Model Name.....	40
4.32	Report Manufacturer Version.....	41
4.33	Report Manufacturer Serial Number.....	41
4.34	Report Min Rated Voltage	42
4.35	Report Max Rated Voltage	42
4.36	Report Max Rated Current.....	42
4.37	Report Max Rated Power	43
4.38	Report Max Rated Ambient Temperature.....	43
4.39	Report Min Rated Ambient Temperature	43
4.40	Report CC/CV Mode.....	44
4.41	Report Manufacturer Firmware CRC Value	44
5.	Setting Command.....	56
5.1	Clear Faults	56
5.2	Set Vout Command	56
5.3	Set OPP Fault Limit	56
5.4	Set Fan Command.....	57
6.	PEC Calculation	60

Industrial AC-DC Power Supply

2500W with 5V/2A Standby / PMS-2K5 series

1. Overview

1.1 Introduction

The specification provides a means for all PSUs can use for internal or external communication. And this document describes communication protocols and its utilized methods. All commands mentioned in this document follow the PMBus® protocol standard.

1.2 Referenced Standards

- SMBus Specification Version3.0
- PMBus Specification Part I Revision1.3.1
- PMBus Specification Part II Revision1.3.1

1.3 Acronyms and Definitions

CMD: command

PSU: power supply unit

I2C: inter-integrated circuit

OPP: over power protection

OVP: over voltage protection

UVP: under voltage protection

OTP: over temperature protection

CML: communication, memory or logic

ACK: Acknowledge. The response from a receiving unit indicates that it has received the byte.

NACK: Not Acknowledge. The response from a receiving unit indicates that it has received invalid data.

2. Protocol Descriptions

2.1 Communication Topology

The typical topology is master-slave mode via I2C interface, which host device is defined as master and PSU device is slave. Normally, communication is initiated by master. And the structure is shown as below.

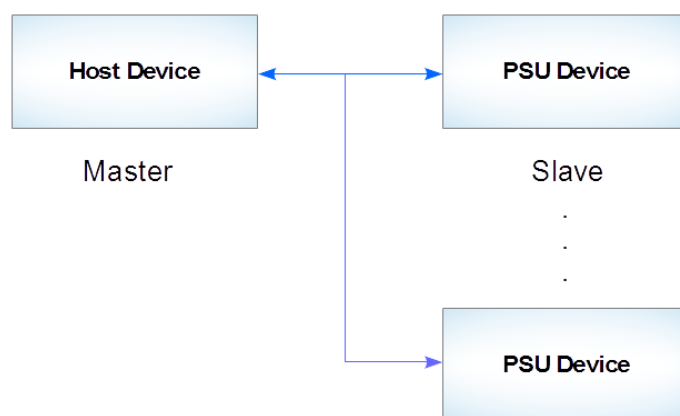

Fig. 1: I2C Topology

2.2 Communication Signal

The communication speed is 100 kbps, and voltage is 5V.

Industrial AC-DC Power Supply

2500W with 5V/2A Standby / PMS-2K5 series

2.3 Address Selection

To communicate with host, each PSU shall have a default address. This address can be different due to projects. As shown in Figure 1, there might be several PSUs at the same time. Therefore, to avoid conflict, each PSU shall have a unique address. And this is realized through address pin A2 to A0. By the combination of address pins, there is up to 8 selections. Address list is shown in the table below.

Table 1: Address List

A2 ¹	A1	A0	PMS-2K5A Series ²
0	0	0	0x30(default)
0	0	1	0x31
0	1	0	0x32
0	1	1	0x33
1	0	0	0x34
1	0	1	0x35
1	1	0	0x36
1	1	1	0x37

Note:

1. A voltage of 5V reflects the symbol '1' in the list, and 0V reflects the symbol '0'.
2. A2 to A0 is located on connector CN605 pin7 to pin9.

2.4 Command Structure

2.4.1 Bit and Byte Illustration

The transmission of bits and bytes is illustrated in this section. In all cases, a byte contains 8 bits and is transferred from MSB to LSB. The LSB is always bit 0, and MSB is always bit 7, as shown in below.

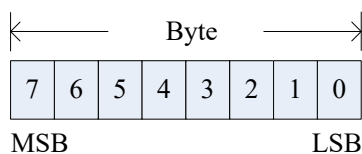

Fig. 2: Byte Illustration

Industrial AC-DC Power Supply

2500W with 5V/2A Standby / PMS-2K5 series

2.4.2 Setting Command

The table below is the typical format of a setting command, the un-shaded bit indicates the data sent from master to slave, and the shaded bit is returned from slave to master.

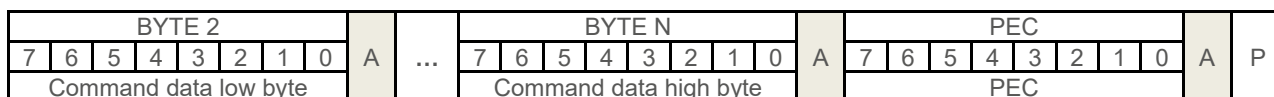
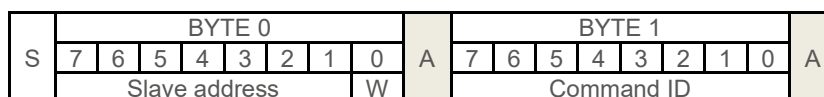

The symbols used to describe this command are shown as below:

Table 2: Command Description

Symbol	Description
S	A start condition sent by a host device
Slave address ¹	First seven bits of the physical address to identify device
W	A value of 0 indicating the device is addressed with a writing command
A	ACK condition sent by a PSU device
Command ID	A byte followed the address byte indicating command type
Command data high byte	Last byte of command data, data length depends on each command
Command data low byte	First byte of command data
PEC	CRC byte of this command, calculated from address byte to the last byte of command data, detail information is referred to Chapter6
P	A stop condition sent by a host device

Note:

- For example, if physical address is 0x30, then slave address is 0b0110000.

Industrial AC-DC Power Supply

2500W with 5V/2A Standby / PMS-2K5 series

2.4.3 Reporting Command

The table below is the typical format of a reporting command, the un-shaded bit indicates the data sent from master to slave, and the shaded bit is from slave to master. If the command ID is not supported by slave, the read data byte should be filled by 0xFF.

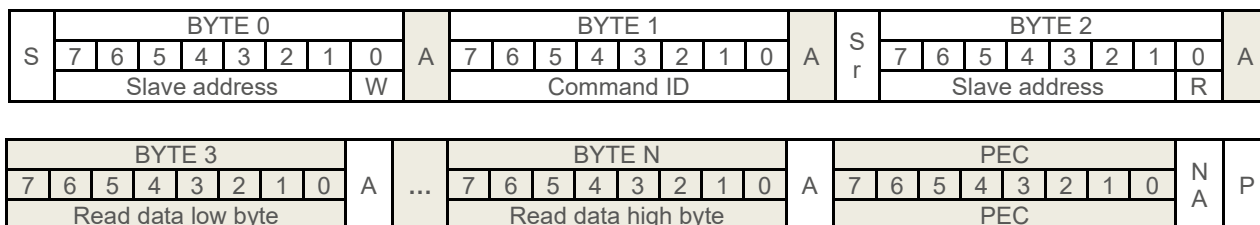

The symbols used to describe this command are shown as below:

Table 3: Command Description

Symbol	Description
Sr	A repeated start condition sent by a host device
R	A value of 1 indicating the device is addressed with a reading command
Read data high byte	Last byte of read data, data length depends on each command
Read data low byte	First byte of read data
NA	NACK condition sent by a host device

3. Command List

The following sets of commands follow the standard PMBus™ protocol specification. And each product will support different commands.

Table 4: Standard PMBus Commands

ID	Name	Data Format	Data Length ¹	PMS-2K5A Series
01h	Operation	N/A ²	1	Write/Read
02h	On Off Configure	N/A	1	Read
03h	Clear Fault	N/A	0	Write
10h	Write Protect	N/A	1	Read
19h	Capability	N/A	1	Read
1Ah	Query	Process Call ⁴	1	Read
20h	Vout Mode	N/A	1	Read
21h	Vout Command	Direct ³	2	Write/Read
24h	Vout Max	Direct	2	Read
2Bh	Vout Min	Direct	2	Read
30h	Coefficients	Process Call	5	Read
3Ah	Fan Configure1/2	N/A	1	Read
3Bh	Fan Command1	Direct	2	Write/Read
3Ch	Fan Command2	Direct	2	Write/Read
40h	Vout OV Fault Limit	Direct	2	Read
41h	Vout OV Response	N/A	1	Read
42h	Vout OV Warn Limit	Direct	2	Write/Read
44h	Vout UV Fault Limit	Direct	2	Read
45h	Vout UV Response	N/A	1	Read
46h	Iout OC Fault Limit	Direct	2	Read

Industrial AC-DC Power Supply

2500W with 5V/2A Standby / PMS-2K5 series

47h	Iout OC Fault Response	Direct	2	Read
4Fh	OT Fault Limit	Direct	2	Read
50h	OT Fault Response	N/A	1	Read
53h	UT Fault Limit	Direct	2	Read
54h	UT Fault Response	N/A	1	Read
68h	Pout OP Fault Limit	Direct	2	Write/Read
69h	Pout OP Response	N/A	1	Read
78h	Status Byte	N/A	1	Read
79h	Status Word	N/A	2	Read
7Ah	Status Vout	N/A	1	Read
7Bh	Status Iout	N/A	1	Read
7Dh	Status Temperature	N/A	1	Read
7Eh	Status CML	N/A	1	Read
80h	Status MFR Specific	N/A	1	Read
81h	Status Fans1/2	N/A	1	Read
8Bh	Read Vout	Direct	2	Read
8Ch	Read Iout	Direct	2	Read
8Dh	Read Temperature1	Direct	2	Read
90h	Read Fan Speed1	Direct	2	Read
91h	Read Fan Speed2	Direct	2	Read
96h	Read Pout	Direct	2	Read
98h	PMBus Revision	N/A	1	Read
99h	MFR ID	N/A	15	Read
9Ah	MFR Model	N/A	15	Read
9Bh	MFR Revision	N/A	15	Read
9Eh	MFR Serial	N/A	15	Read
A4h	MFR Vout Min	Direct	2	Read
A5h	MFR Vout Max	Direct	2	Read
A6h	MFR Iout Max	Direct	2	Read
A7h	MFR Pout Max	Direct	2	Read
A8h	MFR Ambient Temp Max	Direct	2	Read
A9h	MFR Ambient Temp Min	Direct	2	Read

Note:

1. The unit of data length is byte.
2. N/A means no numeric data in this command.
3. Direct means this command contains numeric data, normally low byte data is sent first and then comes the high byte data. Detail information can be obtained via coefficient command (30h).
4. Detail information is referred to command.

Industrial AC-DC Power Supply

2500W with 5V/2A Standby / PMS-2K5 series

The following sets of commands also belong to PMBus™ protocol specification, but defined as manufacturer specific commands. And each product will support different commands.

Table 5: Manufacturer Specific Commands

ID	Name	Data Format	Data Length	PMS-2K5A Series
CBh	Iout Command	Direct	2	Write/Read
CCh	Iout Max	Direct	2	Read
CDh	Iout Min	Direct	2	Read
CEh	Remote Control	N/A	1	Write/Read
CFh	CC/CV Mode	N/A	1	Read
E1h	Fan Duty	N/A	1	Read
E2h	Read MFR Firmware CRC	N/A	2	Read
E3h	Set Iout Cali Coefficient	Direct	2	Write

4. Reporting Command

4.1 Report Vout Mode

This command is for master device to retrieve data form of voltage related commands.

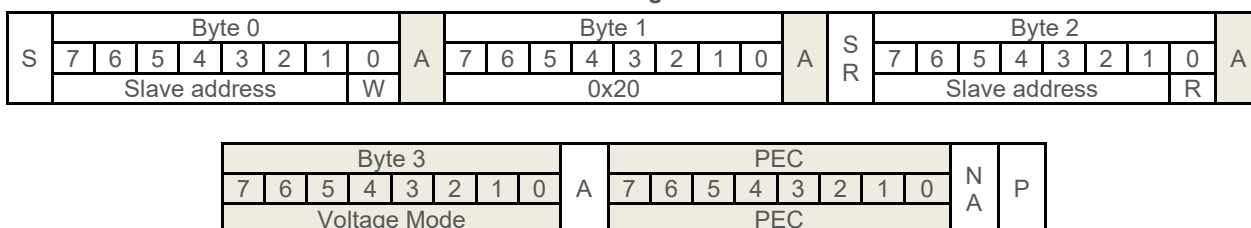

Range:

Voltage Mode Definition:

Bit	Meaning
7	0 -- Absolute / 1 -- Relative
6~5	00 -- Ulinear 16 / 01 -- VID / 10 -- Direct / 11 -- IEEE Half
4~0	TBD

Example:

Command	Description
10 20 11 40 A1	Voltage command is in direct data mode

Note:

Slave address is assumed to be 0b0010000.

Industrial AC-DC Power Supply

2500W with 5V/2A Standby / PMS-2K5 series

4.2 Report Vout Command

This command is for master device to retrieve PSU's voltage reference.

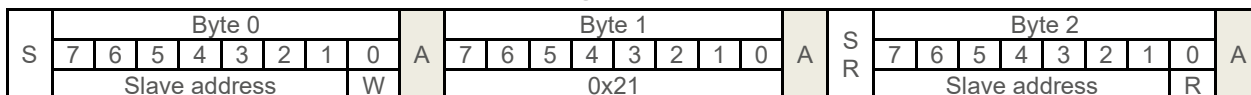

Example:

Command	Description
10 21 11 08 01 8C	Voltage reference is 26.4V

Note:

Report data has two bytes and accuracy is one decimal place. Low byte is sent first, and then comes after the high byte. Therefore, the actual data order is 0x01 0x08, which is 264.

4.3 Report Vout Max

This command is for master device to retrieve PSU's max value of voltage reference.

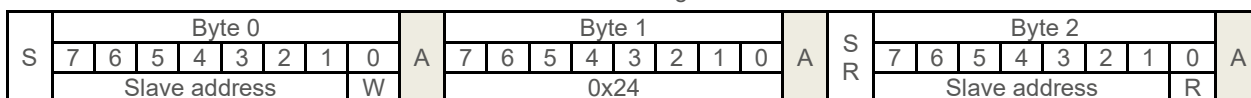

Example:

Command	Description
10 24 11 08 01 C2	Max value of voltage reference is 26.4V

Note:

N/A

4.4 Report Vout Min

This command is for master device to retrieve PSU's min value of voltage reference.

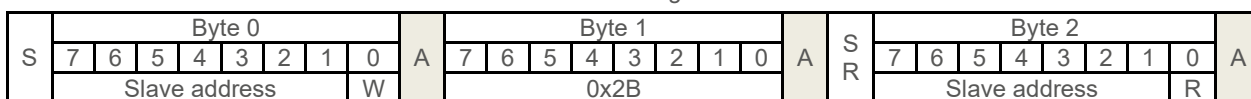

Example:

Command	Description
10 2B 11 D8 00 92	Min value of voltage reference is 21.6V

Note:

N/A

Industrial AC-DC Power Supply

2500W with 5V/2A Standby / PMS-2K5 series

4.5 Report Coefficients

This command is for master device to retrieve PSU's m, b and R coefficients needed by data in direct format.

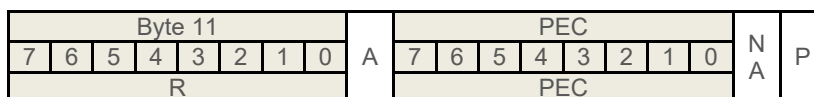
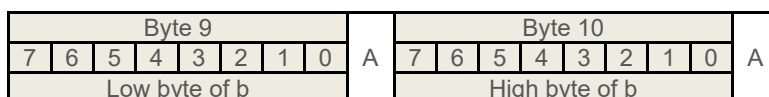
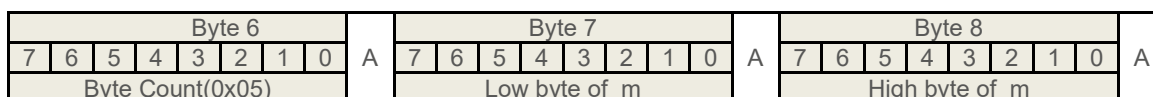
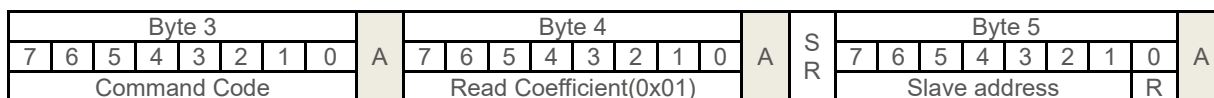
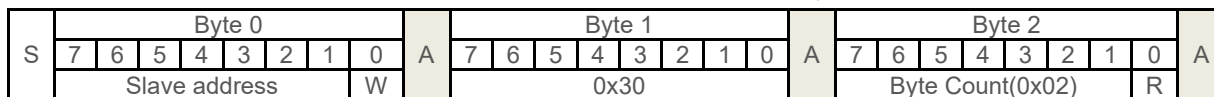

Example:

Command	Description
10 30 02 21 01 11 05 01 00 00 00 01 5D	The coefficients of Vout command are m is 1, b is 0 and R is 1.

Note:

By selecting command ID in command code byte, this command provides a method for master to retrieve coefficient information of each command in direct data format.

A host device must use the following equation to convert the reporting data from PSU into the actual value in "real word".

$$\text{Actual Value} = \frac{1}{m}(\text{Report data} \times 10^{-R} - b)$$

Where:

m is the slope with two bytes, b is the offset with two bytes and R is exponent with one byte. And all m, b and R is two's complement integer.

And to send a value, a host device must use the following equation to transfer data for PSU.

$$\text{Sending data} = (m \times \text{Actual value} + b) \times 10^R$$

Where m, b and R is same above.

Take Vout command as example, the coefficients of Vout command are m is 1, b is 0 and R is 1. Therefore, if reporting data is 264(0x01 0x08), it means the actual voltage reference is 26.4V. And also if host wants to set PSU voltage reference to 26.4V, sending data shall be 264. However, if selecting a command ID in N/A format, then all coefficients data returned is 0x00.

Industrial AC-DC Power Supply

2500W with 5V/2A Standby / PMS-2K5 series

4.6 Report Fan Configuration

This command is for master device to retrieve fan configuration information in PSU.

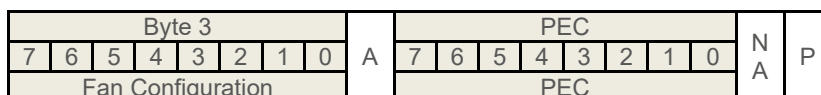
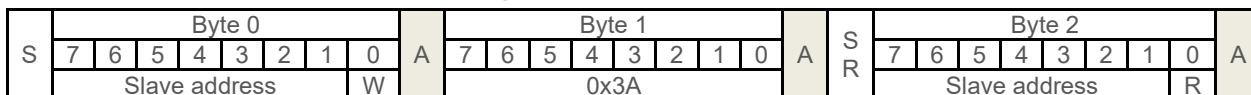

Range:

Fan Configuration Definition:

Bit	Meaning
7	0 -- Fan1 not install / 1 -- Fan1 installed
6	0 -- Fan1 in duty cycle mode / 1 -- Fan1 in R.P.M mode
5~4	00 -- 1 pulse / 01 -- 2 pulses / 10 -- 3 pulses / 11 -- 4 pulses per revolution
3	0 -- Fan2 not install / 1 -- Fan2 installed
2	0 -- Fan2 in duty cycle mode / 1 -- Fan2 in R.P.M mode
1~0	00 -- 1 pulse / 01 -- 2 pulses / 10 -- 3 pulses / 11 -- 4 pulses per revolution

Example:

Command	Description
10 3A 11 99 85	Fan1 and fan2 is installed in duty with 2 pulses per revolution

Note:

N/A

4.7 Report Fan Command 1

This command is for master device to retrieve PSU's current fan 1 duty value.

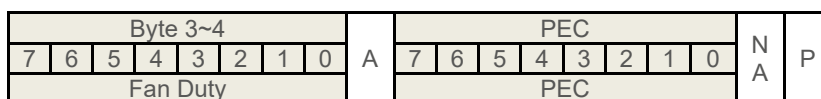
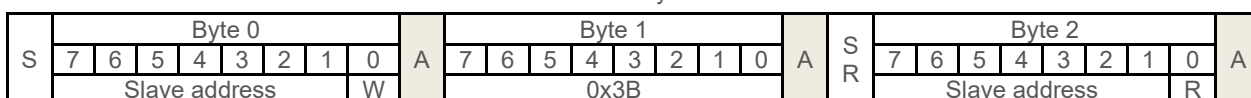

Example:

Command	Description
10 3B 11 2C 01 8D	Fan 1 current duty is 30.0%

Note:

1. Slave address is assumed to be 0b0010000 in the example.
2. Report data has two bytes, the unit is rpm. Low byte is sent first, and then comes after the high byte.
3. In multichannel PSU, the value returned is the information of selected page.

Industrial AC-DC Power Supply

2500W with 5V/2A Standby / PMS-2K5 series

4.8 Report OVP Fault Limit

This command is for master device to retrieve PSU's OVP value.

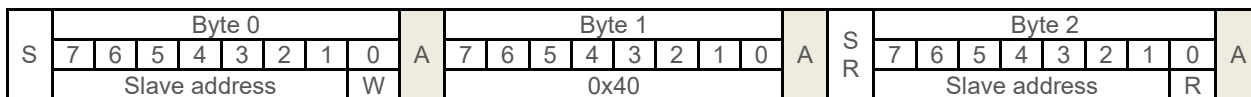

Example:

Command	Description
10 40 11 18 01 98	OVP fault limit is 28.0V

Note:

Report data is 0xFF when this protection is disabled in PSU.

4.9 Report OVP Fault Response

This command is for master device to retrieve PSU's OVP response.

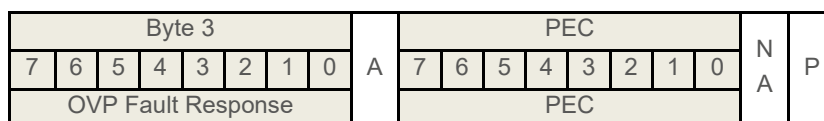

Range:

OVP Fault Response Definition:

Bit	Meaning
7~6	10 -- PSU latched / 11 -- PSU auto restart when fault recovered
5~0	TBD

Example:

Command	Description
10 41 11 80 41	PSU is latched when OVP happened

Note:

N/A

Industrial AC-DC Power Supply

2500W with 5V/2A Standby / PMS-2K5 series

4.10 Report UVP Fault Limit

This command is for master device to retrieve PSU's UVP value.

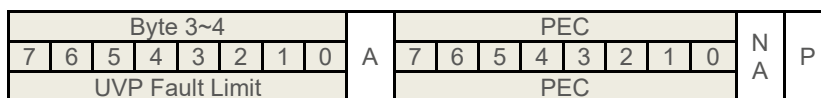
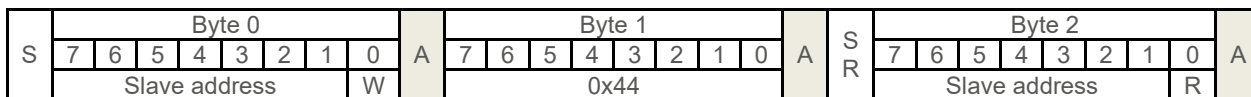

Example:

Command	Description
10 44 11 B4 00 23	UVP fault limit is 18.0V

Note:

Report data is 0xFF when this protection is disabled in PSU.

4.11 Report UVP Fault Response

This command is for master device to retrieve PSU's UVP response.

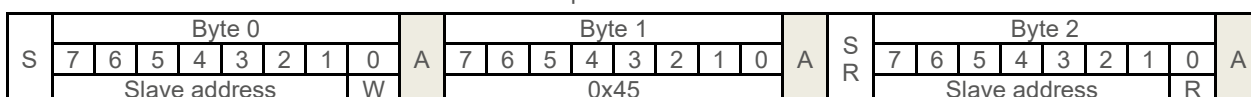

Range:

UVP Fault Response Definition:

Bit	Meaning
7~6	10 -- PSU latched / 11 -- PSU auto restart when fault recovered
5~0	TBD

Example:

Command	Description
10 45 11 C0 2D	PSU auto restart when UVP removed

Note:

N/A

4.12 Report OTP Fault Limit

This command is for master device to retrieve PSU's OTP value.

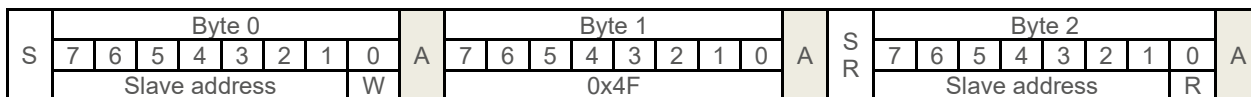

Example:

Command	Description
10 4F 11 7E 04 DA	OTP fault limit is 115.0°C

Note:

Report data is 0xFF when this protection is disabled in PSU.

Industrial AC-DC Power Supply

2500W with 5V/2A Standby / PMS-2K5 series

4.13 Report OTP Fault Response

This command is for master device to retrieve PSU's OTP response.

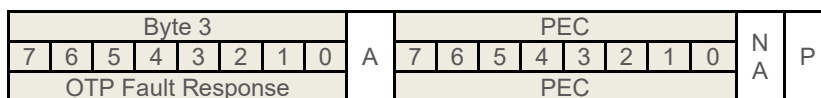
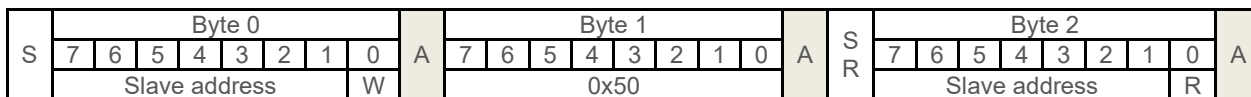

Range:

OTP Fault Response Definition:

Bit	Meaning
7~6	10 -- PSU latched / 11 -- PSU auto restart when fault recovered
5~0	TBD

Example:

Command	Description
10 50 11 80 41	PSU is latched when OTP happened

Note:

N/A

4.14 Report OPP Fault Limit

This command is for master device to retrieve PSU's OPP value.

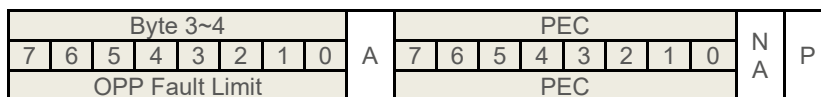
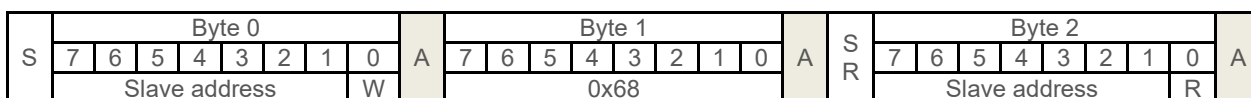

Example:

Command	Description
10 68 11 E8 35 7E	OPP fault limit is 1380.0W

Note:

Report data is 0xFF when this protection is disabled in PSU.

Industrial AC-DC Power Supply

2500W with 5V/2A Standby / PMS-2K5 series

4.15 Report OPP Fault Response

This command is for master device to retrieve PSU's OPP response.

S	Byte 0								A	Byte 1								A	S	R	Byte 2								A
	7	6	5	4	3	2	1	0		7	6	5	4	3	2	1	0				7	6	5	4	3	2	1	0	
Slave address								W	0x69								Slave address								R				

Byte 3								A	PEC								N	A	P
7	6	5	4	3	2	1	0		7	6	5	4	3	2	1	0			
OPP Fault Response								PEC											

Range:

OPP Fault Response Definition:

Bit	Meaning
7~6	10 -- PSU latched / 11 -- PSU auto restart when fault recovered
5~0	TBD

Example:

Command	Description
10 69 11 80 53	PSU is latched when OPP happened

Note:

N/A

4.16 Report Status Byte

This command is for master device to retrieve one byte of information with a summary of the most critical faults in PSU.

S	Byte 0								A	Byte 1								A	S	R	Byte 2								A
	7	6	5	4	3	2	1	0		7	6	5	4	3	2	1	0				7	6	5	4	3	2	1	0	
Slave address								W	0x78								Slave address								R				

Byte 3								A	PEC								N	A	P
7	6	5	4	3	2	1	0		7	6	5	4	3	2	1	0			
Status Byte								PEC											

Range:

Status Byte Definition:

Bit	Meaning
7	0 -- PSU normal / 1 -- PSU busy
6	0 -- PSU normal / 1 -- PSU power off
5	0 -- PSU normal / 1 -- PSU OVP fault
4	0 -- PSU normal / 1 -- PSU OCP fault
3	0 -- PSU normal / 1 -- PSU input under-voltage fault
2	0 -- PSU normal / 1 -- PSU temperature related fault
1	0 -- PSU normal / 1 -- PSU CML related fault
0	0 -- PSU normal / 1 -- Other fault

Example:

Command	Description
10 78 11 00 13	PSU has no faults

Note:

N/A

Industrial AC-DC Power Supply

2500W with 5V/2A Standby / PMS-2K5 series

4.17 Report Status Word

This command is for master device to retrieve two bytes of information with a summary of faults in PSU.

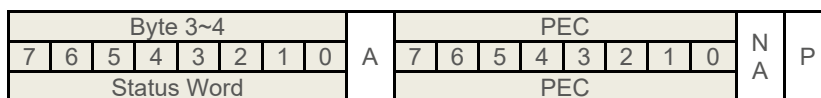
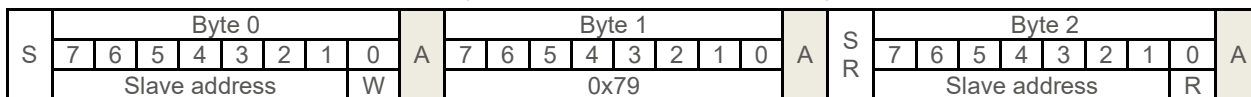

Range:

Status Word Definition:

Bit	Meaning
15	0 -- PSU normal / 1 -- PSU voltage related fault
14	0 -- PSU normal / 1 -- PSU current or power related fault
13	0 -- PSU normal / 1 -- PSU input related fault
12	0 -- PSU normal / 1 -- PSU manufacturer specific fault
11	0 -- PSU normal / 1 -- PSU power good signal fault
10	0 -- PSU normal / 1 -- PSU fan related fault
9	0 -- PSU normal / 1 -- Other fault
8	0 -- PSU normal / 1 -- PSU unknown fault
7	0 -- PSU normal / 1 -- PSU busy
6	0 -- PSU normal / 1 -- PSU power off
5	0 -- PSU normal / 1 -- PSU OVP fault
4	0 -- PSU normal / 1 -- PSU OCP fault
3	0 -- PSU normal / 1 -- PSU input under-voltage fault
2	0 -- PSU normal / 1 -- PSU temperature related fault
1	0 -- PSU normal / 1 -- PSU CML related fault
0	0 -- PSU normal / 1 -- Other fault

Example:

Command	Description
10 79 11 00 00 6F	PSU has no faults

Note:

The low byte of status word is same with status byte. Low byte is send first, and then comes the high byte.

Industrial AC-DC Power Supply

2500W with 5V/2A Standby / PMS-2K5 series

4.18 Report Vout Status

This command is for master device to retrieve one byte of information with a summary of output voltage related faults in PSU.

S	Byte 0								A	Byte 1								A	S	R	Byte 2								A
	7	6	5	4	3	2	1	0		7	6	5	4	3	2	1	0				7	6	5	4	3	2	1	0	
Slave address									W	0x7A									Slave address									R	

Byte 3								A	PEC								N	A	P	
7	6	5	4	3	2	1	0		7	6	5	4	3	2	1	0				
Vout Status									PEC											

Range:

Vout Status Definition:

Bit	Meaning
7	0 -- PSU normal / 1 -- PSU OVP fault
6	0 -- PSU normal / 1 -- PSU OVP warning
5	0 -- PSU normal / 1 -- PSU UVP warning
4	0 -- PSU normal / 1 -- PSU UVP fault
3	0 -- PSU normal / 1 -- PSU voltage reference range invalid
2	TBD
1	TBD
0	TBD

Example:

Command	Description
10 7A 11 00 C5	PSU has no faults

Note:

N/A

4.19 Report Iout Status

This command is for master device to retrieve one byte of information with a summary of output current related faults in PSU.

S	Byte 0								A	Byte 1								A	S	R	Byte 2								A
	7	6	5	4	3	2	1	0		7	6	5	4	3	2	1	0				7	6	5	4	3	2	1	0	
Slave address									W	0x7B									Slave address									R	

Byte 3								A	PEC								N	A	P	
7	6	5	4	3	2	1	0		7	6	5	4	3	2	1	0				
Iout Status									PEC											

Range:

Iout Status Definition:

Bit	Meaning
7	0 -- PSU normal / 1 -- PSU OCP fault
6	TBD
5	0 -- PSU normal / 1 -- PSU OCP warning
4	0 -- PSU normal / 1 -- PSU UCP fault
3	0 -- PSU normal / 1 -- PSU current share fault
2	TBD
1	0 -- PSU normal / 1 -- PSU OPP fault
0	0 -- PSU normal / 1 -- PSU OPP warning

Example:

Command	Description
10 7B 11 00 AE	PSU has no faults

Note:

N/A

Industrial AC-DC Power Supply

2500W with 5V/2A Standby / PMS-2K5 series

4.20 Report Temperature Status

This command is for master device to retrieve one byte of information with a summary of temperature related faults in PSU.

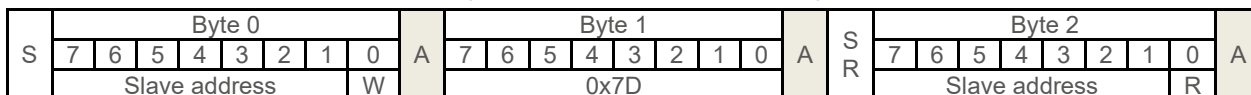

Range:

Temperature Status Definition:

Bit	Meaning
7	0 -- PSU normal / 1 -- PSU OTP fault
6	0 -- PSU normal / 1 -- PSU OTP warning
5	0 -- PSU normal / 1 -- PSU UTP fault
4	0 -- PSU normal / 1 -- PSU UTP warning
3	Reserved
2	Reserved
1	Reserved
0	Reserved

Example:

Command	Description
10 7D 11 00 D3	PSU has no faults

Note:
N/A

4.21 Report CML Status

This command is for master device to retrieve one byte of information with a summary of communications, logic and memory faults in PSU.

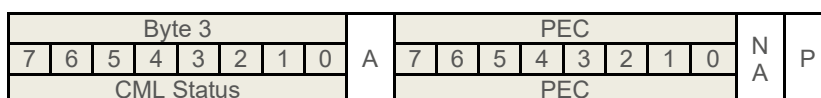
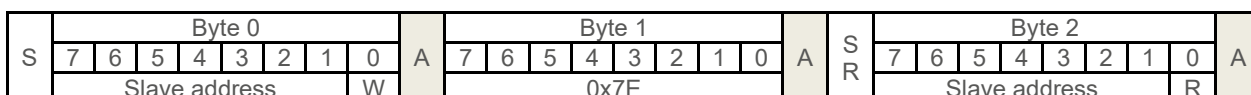

Range:

CML Status Definition:

Bit	Meaning
7	0 -- PSU normal / 1 -- Invalid or unsupported command received
6	0 -- PSU normal / 1 -- Invalid or unsupported data received
5	0 -- PSU normal / 1 -- PEC check fail
4	TBD
3	TBD
2	TBD
1	TBD
0	TBD

Example:

Command	Description
10 7E 11 00 6E	PSU has no faults

Note:
N/A

Industrial AC-DC Power Supply

2500W with 5V/2A Standby / PMS-2K5 series

4.22 Report Manufacturer Specific Status

This command is for master device to retrieve one byte of information with a summary of manufacturer specific faults in PSU.

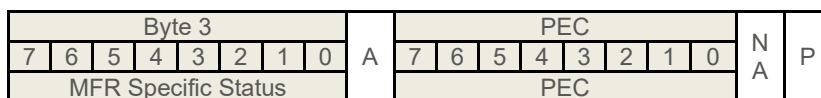
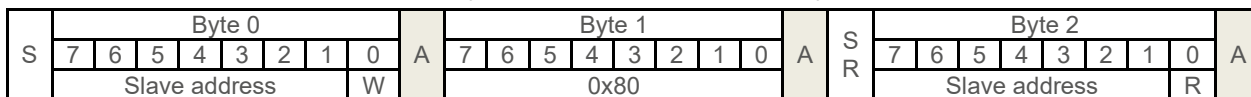

Range:

MFR Specific Definition:
PMS-2K5A series:

Bit	Meaning
7	0 -- PSU normal / 1 -- PSU current reference range invalid
6	0 -- PSU normal / 1 -- PSU AC OK lost
5	0 -- PSU normal / 1 -- PSU AC brown out
4	0 -- PSU normal / 1 -- PSU hardware fault
3	Reserved
2	Reserved
1	Reserved
0	Reserved

Example:

Command	Description
10 80 11 00 2E	PSU has no faults

Note:
N/A

4.23 Report Fan Status

This command is for master device to retrieve one byte of information with a summary of fan related faults in PSU.

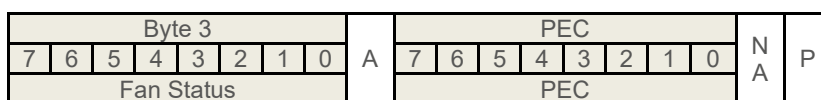
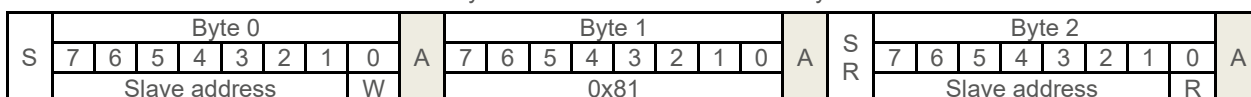

Range:

Fan Status Definition:

Bit	Meaning
7	0 -- PSU normal / 1 -- PSU fan1 fault
6	0 -- PSU normal / 1 -- PSU fan2 fault
5	TBD
4	TBD
3	TBD
2	TBD
1	TBD
0	TBD

Example:

Command	Description
10 81 11 00 45	PSU has no faults

Note:

1. Slave address is assumed to be 0b0010000 in the example.
2. Report data has two bytes, the unit is rpm. Low byte is sent first, and then comes after the high byte.
3. In multichannel PSU, the value returned is the information of selected page.

Industrial AC-DC Power Supply

2500W with 5V/2A Standby / PMS-2K5 series

4.24 Report Output Voltage

This command is for master device to retrieve PSU's output voltage.

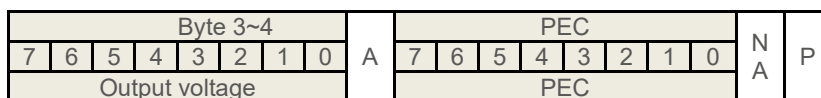
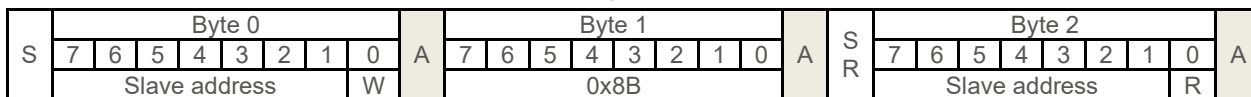

Example:

Command	Description
10 8B 11 4A 01 9E	Output voltage is 3.30V

Note:

N/A

4.25 Report Output Current

This command is for master device to retrieve PSU's output current.

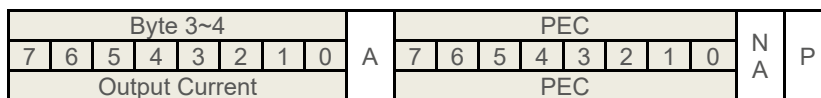
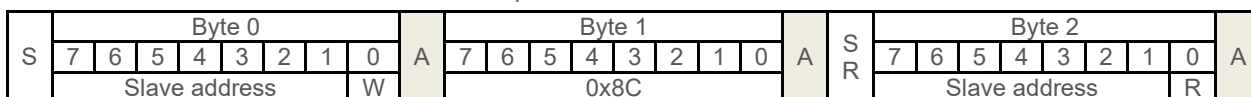

Example:

Command	Description
10 8C 11 4A 01 FC	Output current is 3.30A

Note:

N/A

4.26 Report Temperature

This command is for master device to retrieve PSU's temperature.

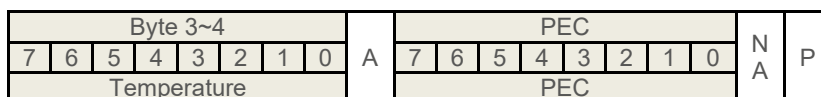
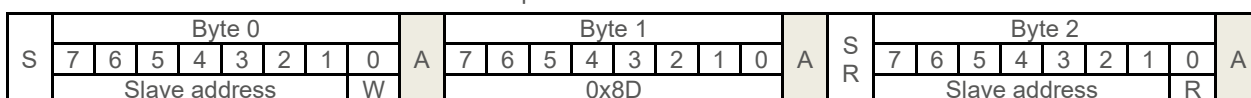

Example:

Command	Description
10 8D 11 4A 01 EA	Temperature is 33.0°C

Note:

N/A

Industrial AC-DC Power Supply

2500W with 5V/2A Standby / PMS-2K5 series

4.27 Report Fan Speed 1

This command is for master device to retrieve PSU's fan 1 speed in R.P.M.

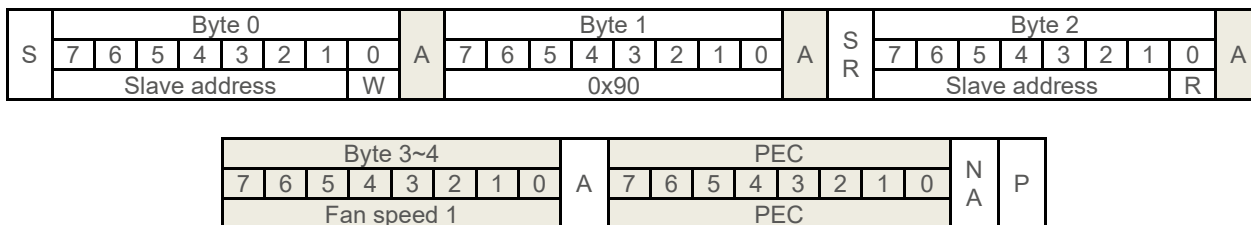

Example:

Command	Description
10 90 11 58 1B 48	Fan speed 1 is 7000 rpm

Note:

1. Slave address is assumed to be 0b0010000 in the example.
2. Report data has two bytes, the unit is rpm. Low byte is sent first, and then comes after the high byte.
3. In multichannel PSU, the value returned is the information of selected page.

4.28 Report Output Power

This command is for master device to retrieve PSU's output power.

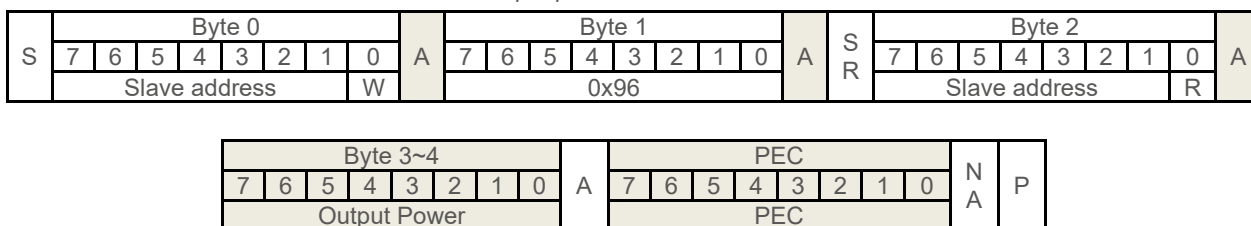

Example:

Command	Description
10 96 11 E0 2E 50	Output power is 1200.0W

Note:

N/A

4.29 Report PMBus Revision

This command is for master device to retrieve PMBus revision.

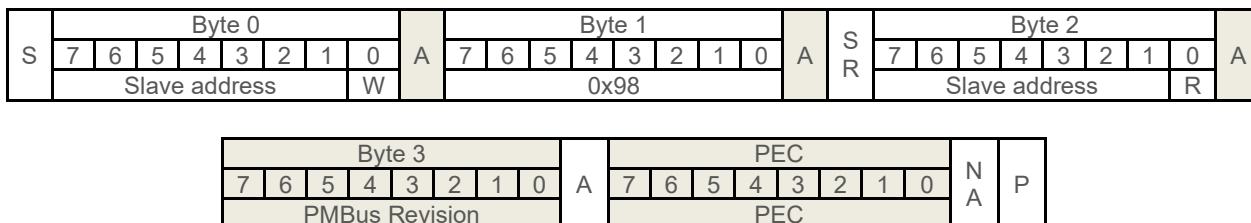

Example:

Command	Description
10 98 11 33 44	PMBus Part I and II revision is 1.3

Note:

The high 4-bit represents PMBus part I, and the low 4-bit represents PMBus part II.

Industrial AC-DC Power Supply

2500W with 5V/2A Standby / PMS-2K5 series

4.30 Report Manufacturer ID

This command is for master device to retrieve manufacturer information.

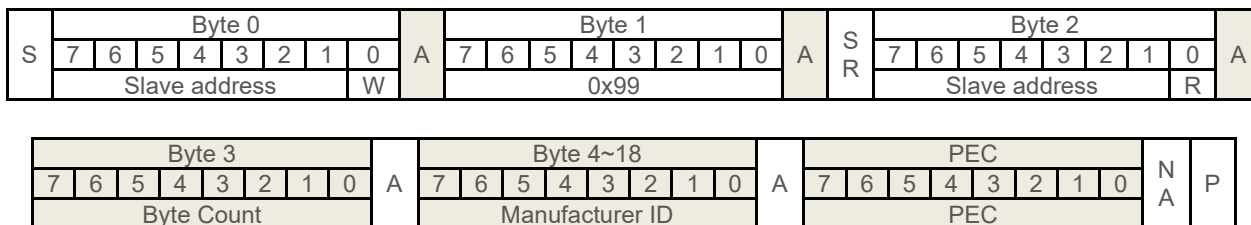

Range:

Manufacturer ID: 15 bytes of ASCII code

Example:

Command	Description
10 99 11 0F 20 20 20 20 20 20 45 42 4E 2D 41 54 4C 45 44 CB	Manufacturer is DELTA-NBE

Note:

Manufacturer ID is in inverted order, and in example above, it is DELTA-NBE plus 6 spacing ASCII code (0x20).

4.31 Report Manufacturer Model Name

This command is for master device to retrieve PSU's model name.

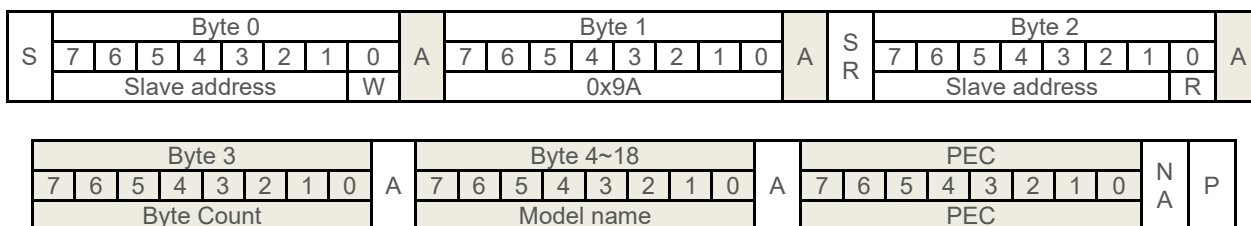

Range:

Model name: 15 bytes of ASCII code

Example:

Command	Description
10 9A 11 0F 41 41 41 20 54 34 32 41 32 4B 31 2D 42 45 4D 69	Model name is PMS-2K5A24T AAA

Note:

Model name is in inverted order, and if length is less than 15 bytes, it shall fill with spacing ASCII code (0x20) from the beginning of model name.

Industrial AC-DC Power Supply

2500W with 5V/2A Standby / PMS-2K5 series

4.32 Report Manufacturer Version

This command is for master device to retrieve PSU's firmware version.

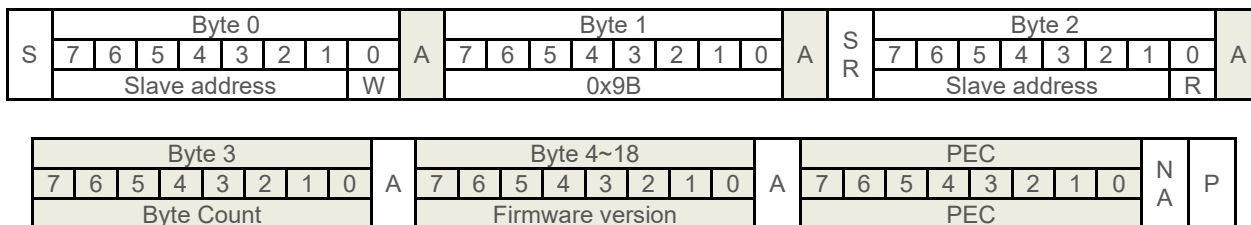

Range:

Manufacturer version: 15 bytes of ASCII code

Example:

Command	Description
10 9B 11 0F 20 20 20 20 20 20 20 20 20 20 30 30 45 30 30 53 8E	Firmware version is S00E00

Note:

Firmware version is in inverted order with 9 spacing ASCII code (0x20) first.

4.33 Report Manufacturer Serial Number

This command is for master device to retrieve PSU's serial number.

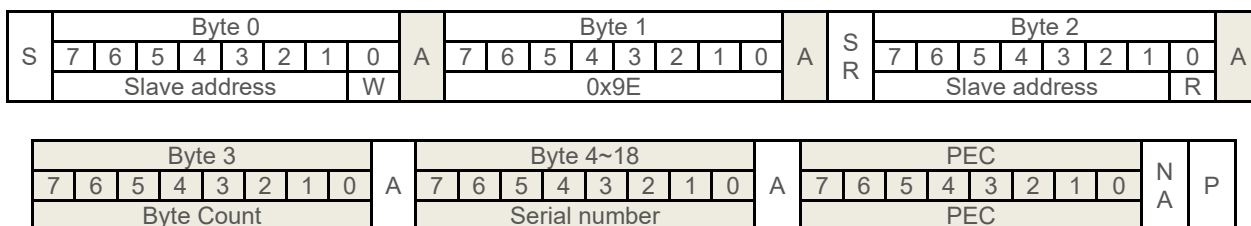

Range:

Serial number: 15 bytes of ASCII code

Example:

Command	Description
10 9E 11 0F 20 20 20 30 31 32 33 34 35 36 37 38 39 41 42 88	Serial number is BA9876543210

Note:

Serial number is in inverted order, and if length is less than 15 bytes, it shall fill with spacing ASCII code (0x20) from the beginning of serial number.

Industrial AC-DC Power Supply

2500W with 5V/2A Standby / PMS-2K5 series

4.34 Report Min Rated Voltage

This command is for master device to retrieve PSU's min rated voltage value.

S	Byte 0								A	Byte 1								A	S	Byte 2								A
	7	6	5	4	3	2	1	0		7	6	5	4	3	2	1	0			7	6	5	4	3	2	1	0	
Slave address									W	0xA4									Slave address									R

Byte 3~4								A	PEC								N	A	P	
7	6	5	4	3	2	1	0		7	6	5	4	3	2	1	0				
Min Rated Voltage									PEC											

Example:

Command	Description
10 A4 11 D8 00 4E	Min rated voltage is 21.6V

Note:

N/A

4.35 Report Max Rated Voltage

This command is for master device to retrieve PSU's max rated voltage value.

S	Byte 0								A	Byte 1								A	S	Byte 2								A
	7	6	5	4	3	2	1	0		7	6	5	4	3	2	1	0			7	6	5	4	3	2	1	0	
Slave address									W	0xA5									Slave address									R

Byte 3~4								A	PEC								N	A	P	
7	6	5	4	3	2	1	0		7	6	5	4	3	2	1	0				
Max Rated Voltage									PEC											

Example:

Command	Description
10 A5 11 08 01 50 E5	Max rated voltage is 26.4V

Note:

N/A

4.36 Report Max Rated Current

This command is for master device to retrieve PSU's max rated current value.

S	Byte 0								A	Byte 1								A	S	Byte 2								A
	7	6	5	4	3	2	1	0		7	6	5	4	3	2	1	0			7	6	5	4	3	2	1	0	
Slave address									W	0xA6									Slave address									R

Byte 3~4								A	PEC								N	A	P	
7	6	5	4	3	2	1	0		7	6	5	4	3	2	1	0				
Max Rated Current									PEC											

Example:

Command	Description
10 A6 11 26 02 AE	Max rated current is 55.0A

Note:

N/A

Industrial AC-DC Power Supply

2500W with 5V/2A Standby / PMS-2K5 series

4.37 Report Max Rated Power

This command is for master device to retrieve PSU's max rated power value.

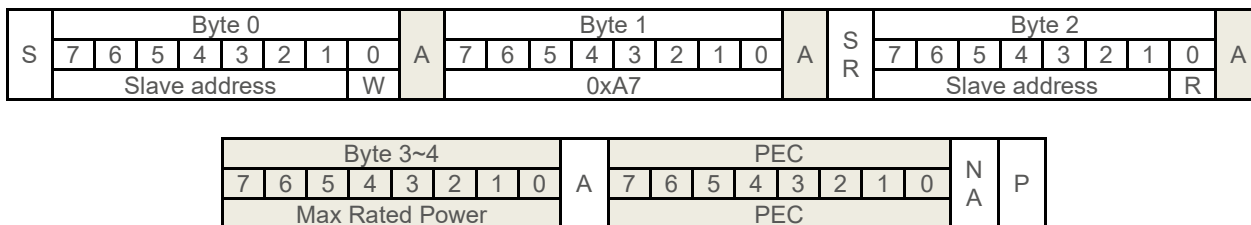

Example:

Command	Description
10 A7 11 E0 2E EF	Max rated power is 1200.0W

Note:

N/A

4.38 Report Max Rated Ambient Temperature

This command is for master device to retrieve PSU's max rated ambient temperature.

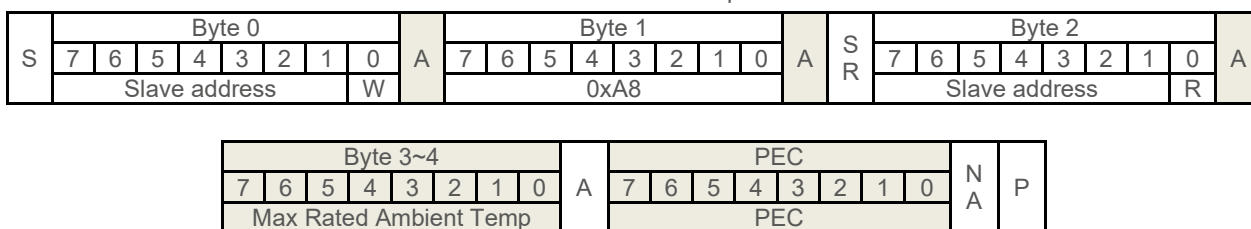

Example:

Command	Description
10 A8 11 BC 02 09	Max rated ambient temperature is 70.0°C

Note:

N/A

4.39 Report Min Rated Ambient Temperature

This command is for master device to retrieve PSU's min rated ambient temperature.

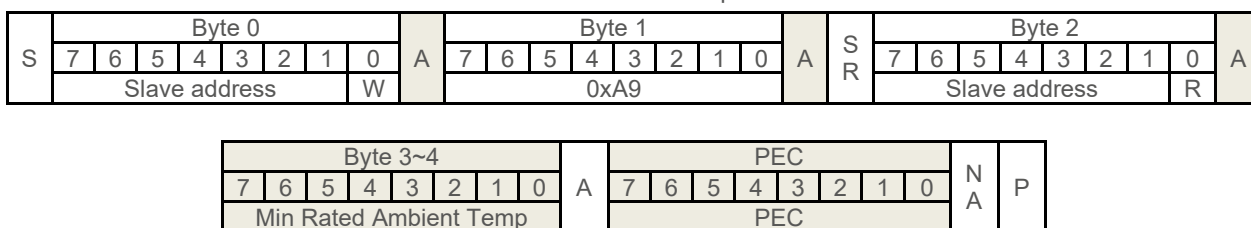

Example:

Command	Description
10 A9 11 38 FF 00	Min rated ambient temperature is -20.0°C

Note:

Min rated ambient temperature is in complement form.

Industrial AC-DC Power Supply

2500W with 5V/2A Standby / PMS-2K5 series

4.40 Report CC/CV Mode

This command is for master device to retrieve PSU's working status.

S	Byte 0								A	Byte 1								A	S	Byte 2								A
	7	6	5	4	3	2	1	0		7	6	5	4	3	2	1	0			7	6	5	4	3	2	1	0	
Slave address									W	0xCF									Slave address									R

Byte 3								A	PEC								N	A	P	
7	6	5	4	3	2	1	0		7	6	5	4	3	2	1	0				
CC/CV Mode									PEC											

Range:

CC/CV Mode Definition:
PMS-2K5A series:

Value	Meaning
0x00	CV Mode
0x01	CC Mode

Example:

Command	Description
10 CF 11 00 EF	PSU is in CV mode.

Note:

N/A

4.41 Report Manufacturer Firmware CRC Value

This command is for master device to retrieve PSU's firmware CRC value.

S	Byte 0								A	Byte 1								A	S	Byte 2								A
	7	6	5	4	3	2	1	0		7	6	5	4	3	2	1	0			7	6	5	4	3	2	1	0	
Slave address									W	0xE2									Slave address									R

Byte 3~4								A	PEC								N	A	P	
7	6	5	4	3	2	1	0		7	6	5	4	3	2	1	0				
Firmware CRC									PEC											

Example:

Command	Description
10 E2 11 BC 02 0E	Firmware CRC is 0x02BC

Note:

N/A

Industrial AC-DC Power Supply

2500W with 5V/2A Standby / PMS-2K5 series

4.42 Report Operation

This command is for master device to get the module on/off status.

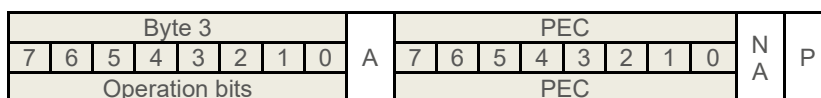
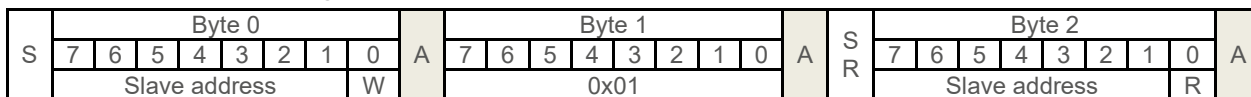

Range:

Operation bits:

BITS	MEANING
7	ON/OFF State:0 -- OFF/1 -- ON
6	Reserved
5	Reserved
4	Reserved
3	Reserved
2	Reserved
1	Reserved
0	Reserved

Example:

COMMAND	DESCRIPTION
10 01 11 00 4E	The module is turn off

Note:

1. Slave address is assumed to be 0b0010000 in the example.
2. In multichannel PSU, the value returned is the information of selected channel.

Industrial AC-DC Power Supply

2500W with 5V/2A Standby / PMS-2K5 series

4.43 Report On Off Configure

This command can be used to get the information including how the PSU will be turned on by enabling the operation command or the global remote on/off signal, or both the polarity of the global remote on/off signal can also be set here. The on off configure flag for turn off delay and fall time (bit 0) is disregarded.

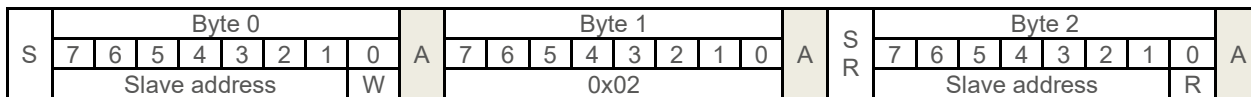

Range:

On/off configure bits:

Bits	Value	Meaning
7:5	000	Reserved
4	0	Unit powers up any time power is present regardless of state of the Global inhibit pin
	1	Unit does not power up until commanded by the Global inhibit pin
3	0	Unit ignores the on/off portion of the OPERATION command from serial bus
	1	To start, the unit requires that the on/off portion of the OPERATION command is instructing the unit to run.
2	0	Unit ignores the Global inhibit pin
	1	Unit requires the Global inhibit pin to be asserted to start the unit.
1	0	Polarity of the Global inhibit pin(active low)
	1	Polarity of the Global inhibit pin(active high)
0	0	Use programmed turn off delay(not used)
	1	Stop as fast as possible

Example:

COMMAND	DESCRIPTION
10 02 11 15 98	The unit does not power up until commanded by the global inhibit pin is low, ignores the on/off portion of the operation command from serial bus. The unit would be stop as fast as possible without delay.

Note:

1. Slave address is assumed to be 0b0010000 in the example.
2. In multichannel PSU, the value returned is the information of all channels.

Industrial AC-DC Power Supply

2500W with 5V/2A Standby / PMS-2K5 series

4.44 Report Write Protect

The write protect command is used to control writing to the PMBus device. The intent of this command is to provide protection against accidental changes. The command is described as below:

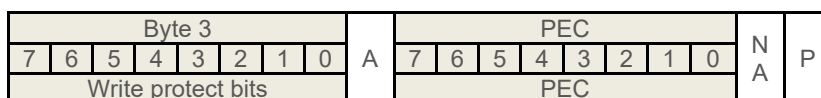
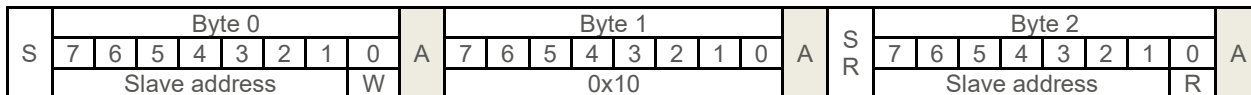

Range:

Write protect bits:

Data byte	Description
1000 0000	Disable all writes except to the WRITE PROTECT command
0100 0000	Disable all writes except to the WRITE PROTECT, OPERATION and PAGE commands
0010 0000	Disable all writes except to the WRITE PROTECT, OPERATION, PAGE, ON OFF CONFIGURE and VOUT COMMAND commands
0000 0000	Enable writes to all commands

Example:

COMMAND	DESCRIPTION
10 10 11 00 87	The current writing status is 00 (Enable writes to all commands)

Note:

1. Slave address is assumed to be 0b0010000 in the example.
2. In multichannel PSU, the value returned is the information of all channels.

Industrial AC-DC Power Supply

2500W with 5V/2A Standby / PMS-2K5 series

4.45 Capability

This read only command provides a way for a host system to get some key capabilities of PMBus device.

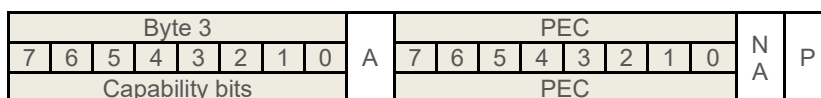
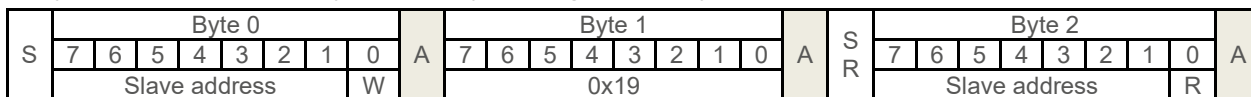

Range:

Capability bits:

Bits	Description	Value	Meaning
7	PEC	0	PEC not supported
		1	PEC supported
6:5	Maximum bus speed	00	100kHz
		01	400kHz
4	PMBUS SMBALERT	0	Not supported
		1	Supported
3	Numeric format	0	Direct
2~0	Reserved		

Example:

COMMAND	DESCRIPTION
10 19 11 90 44	This unit is support PEC, speed 100kHz, support SMBALERT pin, numeric format

Note:

1. Slave address is assumed to be 0b0010000 in the example.
2. This command would report all the modules capability regardless of the selected page.

Industrial AC-DC Power Supply

2500W with 5V/2A Standby / PMS-2K5 series

4.46 Query

The query command is used to ask a PMBus device if it supports a given command, and if so, what data formats it supports for that command.

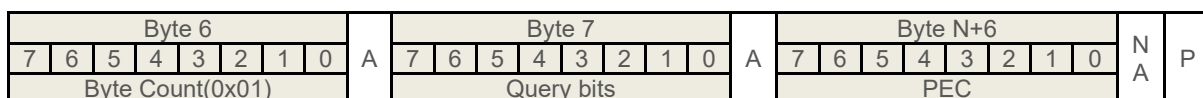
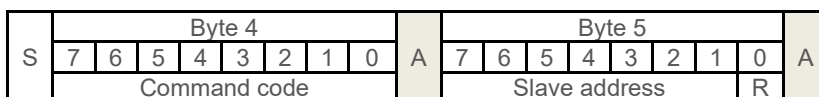
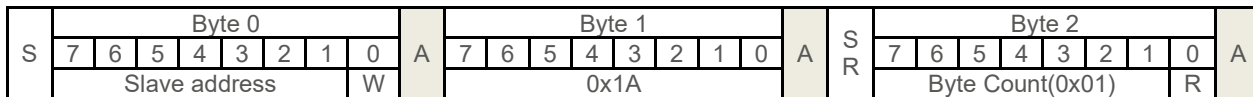

Range:

Query bits:

Bits	Value	Meaning
7	0	Command not supported
	1	Command supported
6	0	Command not supported for write
	1	Command supported for write(regardless of WRITE_PROTECT)
5	0	Command not supported for read
	1	Command supported for read
4:2	000	LINEAR11, ULINEAR16, or SLINEAR16
	001	16 bit signed number
	011	Direct mode format
	100	8 bit unsigned number
	111	Command does not return numeric data.
1~0	xx	Reserved

Example:

COMMAND	DESCRIPTION
10 1A 01 21 11 01 EC BC	Get the Vout command query value, the return value is 0xEC, which is supported for read and write, number format is direct

Note:

1. Slave address is assumed to be 0b0010000 in the example.
2. This command would report all the modules value regardless of the selected page.

Industrial AC-DC Power Supply

2500W with 5V/2A Standby / PMS-2K5 series

4.47 Report Fan Command 2

This command is for master device to retrieve PSU's current fan 2 duty value.

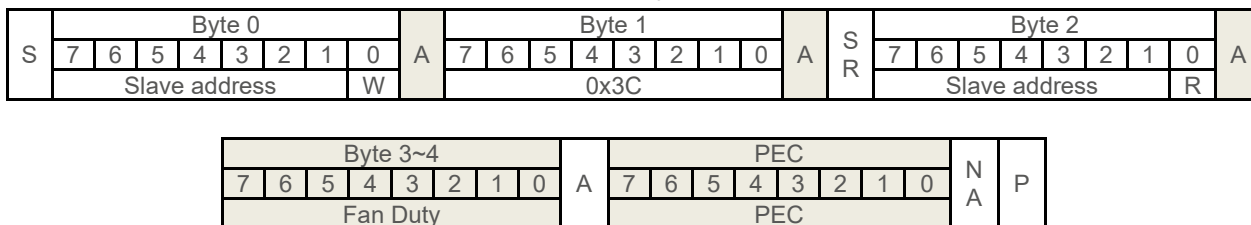

Example:

Command	Description
10 3C 11 2C 01 EF	Fan 2 current duty is 30.0%

Note:

1. Slave address is assumed to be 0b0010000 in the example.
2. Report data has two bytes, the unit is rpm. Low byte is sent first, and then comes after the high byte.
3. In multichannel PSU, the value returned is the information of selected page.

4.48 Report Vout OV Warn Limit

This command is for master device to retrieve PSU's Vout OV warn limit which causes an output over-voltage warning. This value is typically lower than the output over-voltage fault threshold. The data bytes are two bytes formatted according to the setting of the Vout mode command.

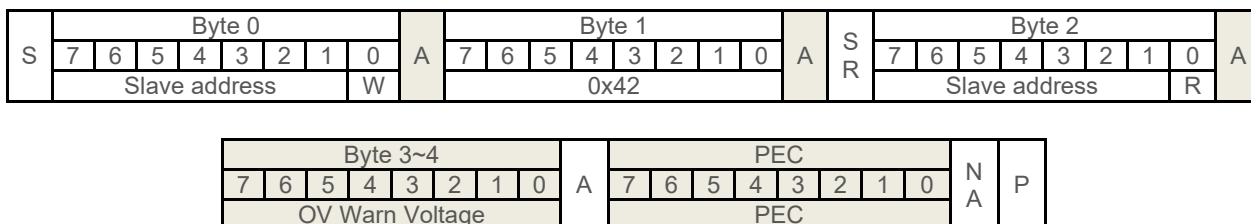

Example:

Command	Description
10 42 1A 04 01 F3	OV warn voltage is 26.0V

Note:

1. Slave address is assumed to be 0b0010000 in the example.
2. Report data has two bytes and accuracy is one decimal place, the unit is Volt. Low byte is sent first, and then comes after the high byte.
3. This command is only supported in multichannel PSU, the value returned is the information of page 0.

Industrial AC-DC Power Supply

2500W with 5V/2A Standby / PMS-2K5 series

4.49 Report lout OC Fault Limit

This command is for master device to retrieve PSU's lout OC fault limit value.

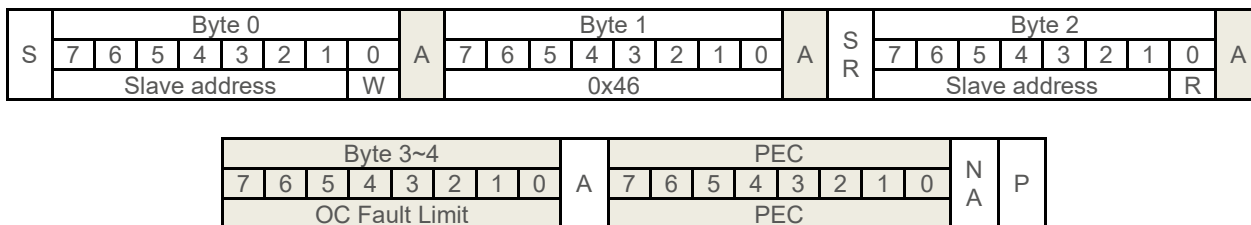

Example:

Command	Description
10 46 11 96 00 8B	OC fault limit is 150.0A

Note:

1. Slave address is assumed to be 0b0010000 in the example.
2. Report data has two bytes and accuracy is one decimal place, the unit is Ampere. Low byte is sent first, and then comes after the high byte.
3. In multichannel PSU, the value returned is the information of selected channel.

4.50 Report lout OC Fault Response

This command is for master device to retrieve PSU's lout OC fault response value.

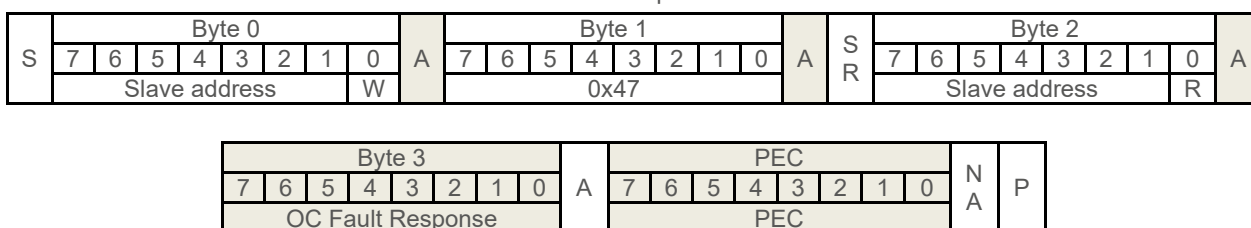

Range:

OC Fault Response Definition:

BIT	MEANING
7~6	10 -- PSU latched / 11 -- PSU auto restart when fault recovered
5~0	TBD

Example:

Command	Description
10 47 11 80 3C	PSU is latched when OC happened

Note:

1. Slave address is assumed to be 0b0001000 in the example.
2. In multichannel PSU, the value returned is the information of all channels.

Industrial AC-DC Power Supply

2500W with 5V/2A Standby / PMS-2K5 series

4.51 Report UTP Fault Limit

This command is for master device to retrieve PSU's UTP value.

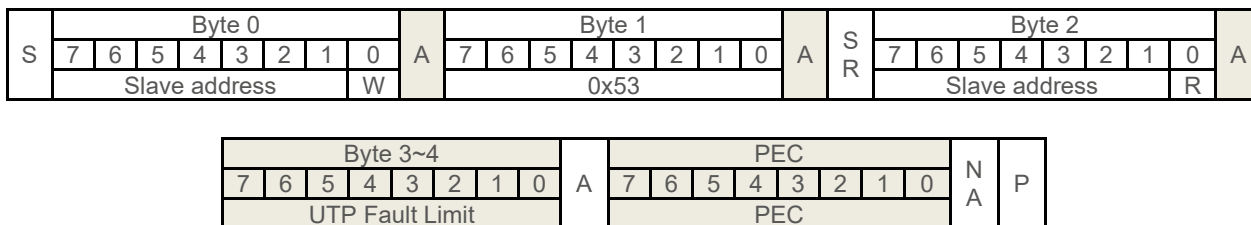

Example:

COMMAND	DESCRIPTION
10 53 11 00 00 3D	UTP fault limit is 0°C

Note:

1. Slave address is assumed to be 0b0010000 in the example.
2. Report data has two bytes and accuracy is one decimal place, the unit is °C. Low byte is sent first, and then comes after the high byte, the value may be below 0.
3. In multichannel PSU, the value returned is the information of selected page.

4.52 Report UTP Fault Response

This command is for master device to retrieve PSU's UTP response.

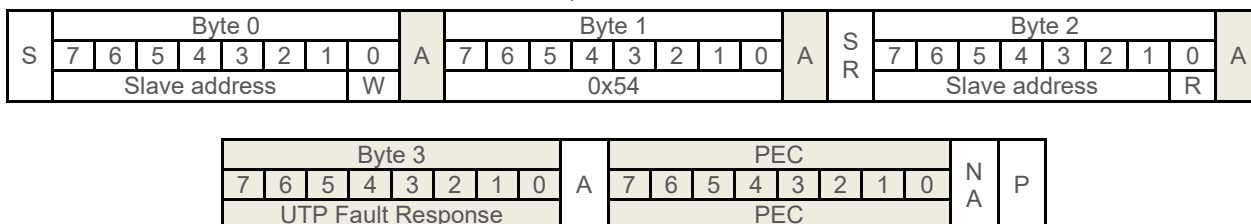

Range:

UTP Fault Response Definition:

BIT	MEANING
7~6	10 -- PSU latched / 11 -- PSU auto restart when fault recovered
5~0	TBD

Example:

COMMAND	DESCRIPTION
10 54 11 80 23	PSU is latched when UTP happened

Note:

1. Slave address is assumed to be 0b0001000 in the example.
2. In multichannel PSU, the value returned is the information of all channels.

Industrial AC-DC Power Supply

2500W with 5V/2A Standby / PMS-2K5 series

4.53 Report Fan Speed 2

This command is for master device to retrieve PSU's fan 2 speed in R.P.M.

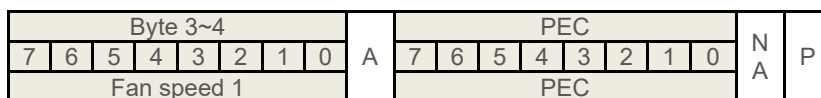
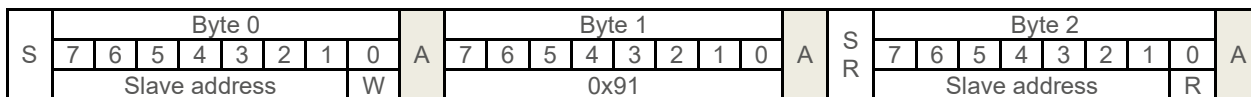

Example:

Command	Description
10 91 11 58 1B 5E	Fan speed 2 is 7000 rpm

Note:

1. Slave address is assumed to be 0b0010000 in the example.
2. Report data has two bytes, the unit is rpm. Low byte is sent first, and then comes after the high byte.
3. In multichannel PSU, the value returned is the information of selected page.

4.54 Report Output Current

This command is for master device to retrieve PSU's current output.



Range:

Iout: 0~6553.5A

Example:

COMMAND	DESCRIPTION
10 CB 11 96 00 44	Output current is 15.0A

Note:

1. Slave address is assumed to be 0b0010000 in the example.
2. Report data has two bytes and accuracy is one decimal place, the unit is Ampere. Low byte is sent first, and then comes after the high byte.

Industrial AC-DC Power Supply

2500W with 5V/2A Standby / PMS-2K5 series

4.55 Report Max Output Current

This command is for master device to retrieve PSU's max current output.

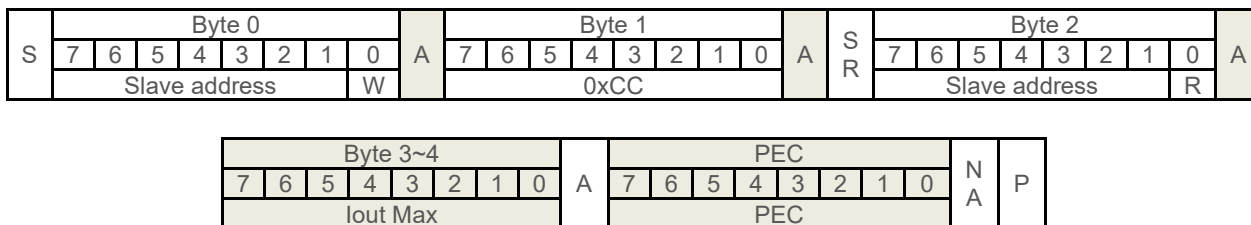

Range:
Iout Max:0~6553.5A

Example:

COMMAND	DESCRIPTION
10 CC 11 96 00 26	Max output current is 15.0A

- Note:**
- Slave address is assumed to be 0b0010000 in the example.
 - Report data has two bytes and accuracy is one decimal place, the unit is Ampere. Low byte is sent first, and then comes after the high byte.
 - In multichannel PSU, the value returned is the information of selected channel.

4.56 Report Min Output Current

This command is for master device to retrieve PSU's max current output.

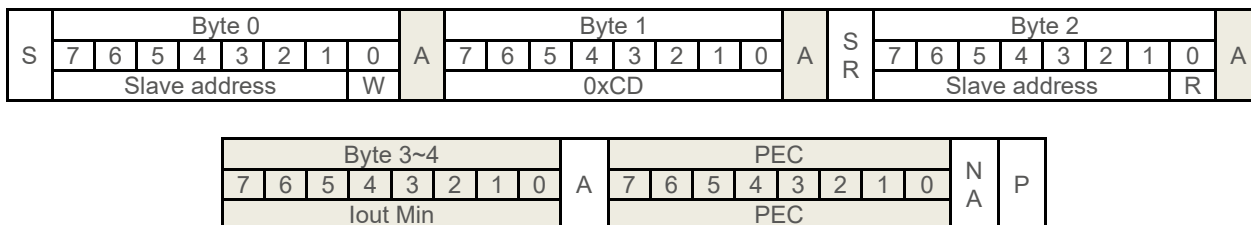

Range:
Iout Min:0~6553.5A

Example:

COMMAND	DESCRIPTION
10 CD 11 96 00 30	Max output current is 15.0A

- Note:**
- Slave address is assumed to be 0b0010000 in the example.
 - Report data has two bytes and accuracy is one decimal place, the unit is Ampere. Low byte is sent first, and then comes after the high byte.
 - In multichannel PSU, the value returned is the information of selected channel.

Industrial AC-DC Power Supply

2500W with 5V/2A Standby / PMS-2K5 series

4.57 Report Remote Control Status

This command is for master device to retrieve PSU's remote control status.

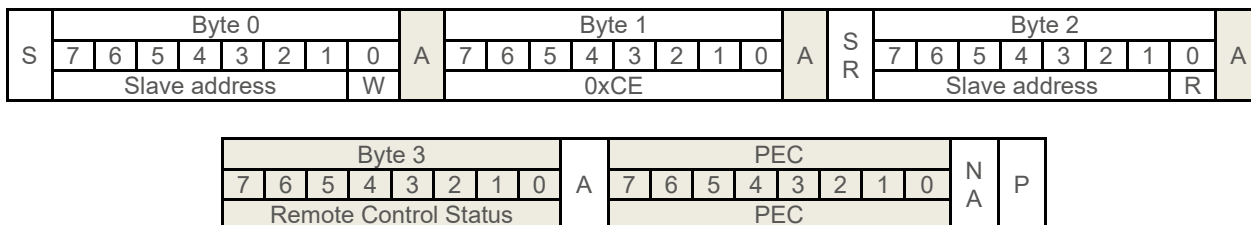

Range:

Remote control status: local--0 / remote--1

Example:

COMMAND	DESCRIPTION
10 CE 11 00 84	The module is local control

Note:

1. Slave address is assumed to be 0b0001000 in the example.
2. The output voltage is controlled by the local VR when the PSU is in local control status, and in remote control, the output voltage can only be modified by the PMBUS
3. In multichannel PSU, the value returned is the information of selected page.

4.58 Report fan duty

This command is for master device to retrieve PSU's fan duty.

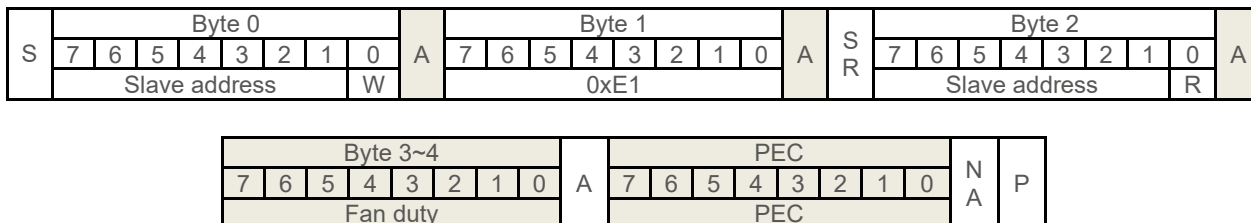

Range:

Fan duty: 0~1000---0.0~100.0%

Example:

COMMAND	DESCRIPTION
10 E1 11 00 32 44	The fan duty is 80.0%

Note:

1. Slave address is assumed to be 0b0010000 in the example.
2. Report data has two bytes and accuracy is one decimal place. Low byte is sent first, and then comes after the high byte.
3. In multichannel PSU, the value returned is the information of selected channel.

Industrial AC-DC Power Supply

2500W with 5V/2A Standby / PMS-2K5 series

5. Setting Command

5.1 Clear Faults

This command is for master device to clear PSU's error status.

S	BYTE 0								A	BYTE 1								A	PEC								N	P	
	7	6	5	4	3	2	1	0		7	6	5	4	3	2	1	0		7	6	5	4	3	2	1	0			
Slave address									W	0x03									PEC										

Example:

Command	Description
10 03 5E	Clear all error status

Note:

There is no data field in this command.

5.2 Set Vout Command

This command is for master device to set PSU's voltage reference.

S	BYTE 0								A	BYTE 1								A	
	7	6	5	4	3	2	1	0		7	6	5	4	3	2	1	0		
Slave address									W	0x21									

BYTE 2~3								A	PEC								N	P	
7	6	5	4	3	2	1	0		7	6	5	4	3	2	1	0			
Voltage Reference									PEC										

Range:

Nominal output voltage $\pm 10\%$

Example:

PMS-2K5A24T AAA: 24V $\pm 10\%$: 21.6~26.4V (t.g.: 21.6 -- 21.6V)

Command	Description
10 21 08 01 E0	Set PSU's voltage reference to 26.4V

Note:

N/A

5.3 Set OPP Fault Limit

This command is for master device to modify PSU's OPP value.

S	BYTE 0								A	BYTE 1								A	
	7	6	5	4	3	2	1	0		7	6	5	4	3	2	1	0		
Slave address									W	0x68									

BYTE 2~3								A	PEC								N	P	
7	6	5	4	3	2	1	0		7	6	5	4	3	2	1	0			
OPP Fault Limit									PEC										

Range:

PMS-2K5A series: $\leq 1380W$

Example:

Command	Description
10 68 10 27 51	Set PSU's OPP fault limit to 1000.0W

Note:

OPP fault limit shall be less than the default fault value shown in range above. And modification is activated when this protection is enabled.

Industrial AC-DC Power Supply

2500W with 5V/2A Standby / PMS-2K5 series

5.4 Set Fan Command 1

This command is for master device to set PSU's fan 1 duty.

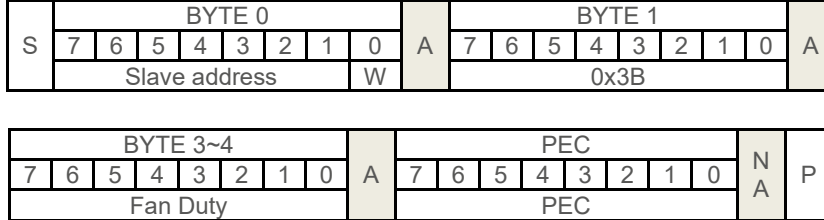

Range:

PMS-2K5A series: current fan 1 duty ~ 100%

Example:

Command	Description
10 3B 2C 01 3F	Set fan1's duty to 30.0%

Note:

As for PMS-2K5A series model, this command is activated when setting value is larger than current fan duty, and deactivated when setting value is zero.

5.5 Set Fan Command 2

This command is for master device to set PSU's fan 2 duty.

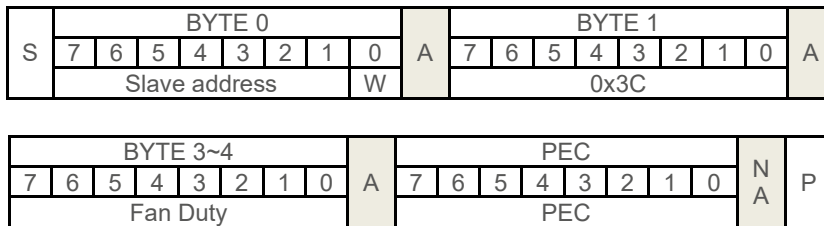

Range:

PMS-2K5A series: current fan 2 duty ~ 100%

Example:

Command	Description
10 3C 2C 01 29	Set fan's duty to 30.0%

Note:

As for PMS-2K5A series model, this command is activated when setting value is larger than current fan duty, and deactivated when setting value is zero.

Industrial AC-DC Power Supply

2500W with 5V/2A Standby / PMS-2K5 series

5.6 Operation

This function is for master device to turn the module on or off.

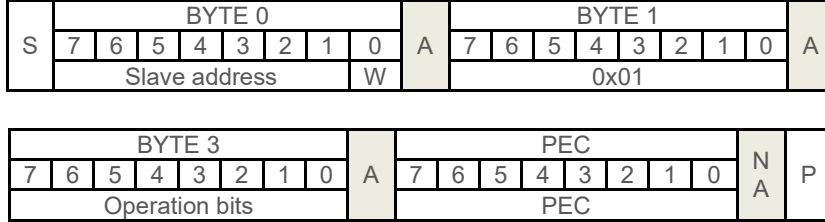

Range:

Operation bits:

BITS	MEANING
7	ON/OFF State:0—OFF 1--ON
6	Reserved
5	Reserved
4	Reserved
3	Reserved
2	Reserved
1	Reserved
0	Reserved

Example:

COMMAND	DESCRIPTION
10 01 00 B7	Turn off the module

Note:

1. Slave address is assumed to be 0b0010000 in the example.
2. In multichannel PSU, the command would only be sent to selected page.

5.7 Set Vout OV Warn Limit

The Vout UV warn limit command sets the value of the PSU output voltage measured at the sense or output pins that causes an output under-voltage warning. This value is typically greater than the output under-voltage fault threshold. The data bytes are two bytes formatted according to the setting of the Vout mode command.

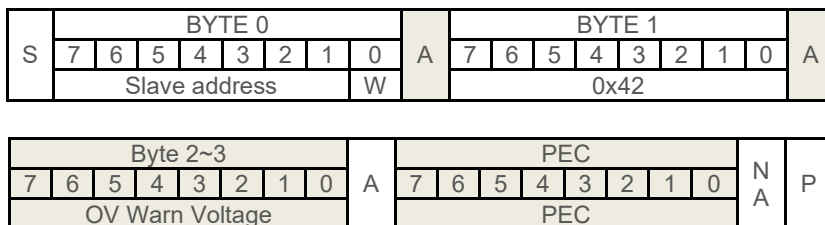

Example:

Command	Description
10 42 04 01 64	OV warn voltage is setting to 26.0V

Note:

1. Slave address is assumed to be 0b0010000 in the example.
2. Command data has two bytes and accuracy is one decimal place, the unit is Volt. Low byte is sent first, and then comes after the high byte.
3. This command is only supported in multichannel PSU, the value returned is the information of page 0.

Industrial AC-DC Power Supply

2500W with 5V/2A Standby / PMS-2K5 series

5.8. Set Iout Command

This command is for master device to set PSU's current reference.

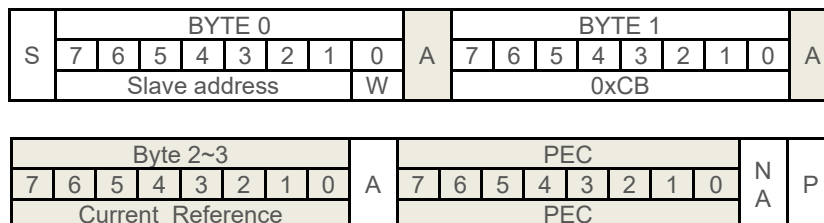

Example:

Command	Description
10 CB 08 01 A9	Set PSU's current reference to 26.4A

Note:

1. Slave address is assumed to be 0b0001000 in the example.
2. Set data has two bytes and accuracy is one decimal place, the unit is Ampere. Low byte is sent first, and then comes after the high byte.

5.9 Remote Control

This command is for master device to set PSU's remote/local control.

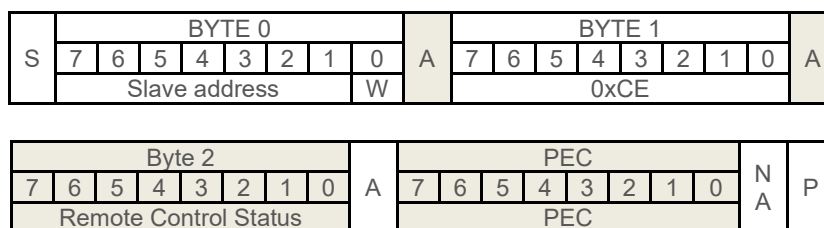

Range:

Remote control status: local--0 / remote--1

Example:

COMMAND	DESCRIPTION
10 CE 00 99	Change the control type to local

Note:

1. Slave address is assumed to be 0b0001000 in the example.
2. The output voltage is controlled by the local VR when the PSU is in local control status, and in remote control, the output voltage can only be modified by the PMBUS.
3. In multichannel PSU, this command would be sent to the selected page.

Industrial AC-DC Power Supply

2500W with 5V/2A Standby / PMS-2K5 series

5.10 Set Iout Cali Coefficient

This command is for master device to calibrate PSU's output current sampling value to accuracy value according to actual value.

S	BYTE 0								A	BYTE 1								A	
	7	6	5	4	3	2	1	0		7	6	5	4	3	2	1	0		
Slave address									W	0xE3									

Byte 2~3								A	PEC								N	P	
7	6	5	4	3	2	1	0		7	6	5	4	3	2	1	0			
Current Calibration Value									PEC										

Example:

Command	Description
10 E3 08 01 BB	PSU's current sampling value is calibrated to 26.4A to be the same with actual value

1. Slave address is assumed to be 0b0010000 in the example.
2. The calibration value should not be higher than 110% of current output current, and lower than 90% of current output current.

6. PEC Calculation

The PEC calculation method is CRC8 ($P(x) = x^8 + x^2 + x^1 + 1$). Take command 5301065046434F4E20 for example, the CRC8 result is AD

hi_crc()={00, 70, e0, 90, c7, b7, 27, 57, 89, f9, 69, 19, 4e, 3e, ae, de}

lo_crc()={00, 07, 0e, 09, 1c, 1b, 12, 15, 38, 3f, 36, 31, 24, 23, 2a, 2d}

1. Divided command 5301065046434F4E20 to nine bytes as 53 01 06 50 46 43 4F 4E 20
2. Define pec = 0; abvalue = 53 (the first byte)
3. pec XOR abvalue, the result is 0101 0011. High byte = 5, low byte = 3.
4. Check the array above, hi_crc(5) = B7; lo_crc(3) = 09. B7 XOR 09 = 1011 1110 = pec.
5. abvalue = 01(the second byte in the command) and return to step 3.
6. When all the bytes in the command are finished, the crc8 result is pec.