

PMR Panel Mount Power Supply

PMR 1500W series / PMR-□V1K5W1BT□



PLEASE READ AND FULLY UNDERSTAND THIS USER MANUAL BEFORE UNPACK AND INSTALL THE POWER SUPPLY

Table of Contents

1.	General safety information	2
1.1	Safety instructions	3
1.2	Warning	4
2.	General overview.....	5
2.1	General Description	5
2.2	Connections.....	6
2.3	Installation Instruction	9
3.	Electrical Functions of Main output.....	13
3.1	Start-up timing	13
3.2	Rise Time	14
3.3	Hold up time.....	14
3.4	Protections.....	15
3.4.1	Over voltage protection (OVP).....	15
3.4.2	Over load	15
3.4.3	Short circuit protection (SCP)	15
3.4.4	Over temperature protection.....	15
3.5	Remote On_Off control.....	16
3.6	Voltage Adjustment.....	17
3.7	Parallel operation.....	18

PMR Panel Mount Power Supply

PMR 1500W series / PMR-□V1K5W1BT□



Highlight & Features

- Up to 1500 Watt in 5" x 8.03" x 1.59" Package
- Up to 23.5W/inch³ Power Density
- Full Power up to 50°C Ambient
- Up to 500KHrs MTBF
- 5V/2A Standby Output
- Active Current Sharing
- Conformal Coating
- Class B Conducted and Radiated EMI
- Remote On/Off control Analog
- Analog Voltage Trimming
- Intelligent Fan Speed Control

1. General safety information

In the user manual, contains four kinds of safety tips: DANGER, WARNING, CAUTION and NOTE. Before reading this manual, you must have a fully understanding of these safety tips.

Safety tips are defined as follows:



If described event is unavoidable, it will cause serious physical injury or death to service engineer, operator, patient, or other personnel.



If described event is unavoidable, it will be occurred serious physical injury for service engineer, operator, patient or other personnel, or catastrophic damage for the power supply or any electronic devices connected to the power supply, or to lose important data or system operation chaos.



If described event is unavoidable, it will be occurred physical injury for service engineer, operator, patient or other personnel, or damage the power supply or any electronic devices connected to the power supply, or to lose data or system operation chaos.



If described event is unavoidable, it will be provided to alert relevant personnel who can contact with the power supply that serious injury will result if the hazard identified is ignored.

PMR Panel Mount Power Supply

PMR 1500W series / PMR-□V1K5W1BT□

1.1 Safety instructions

Installation:

Requirements of IEC/EN 62368-1 shall be observed during the installation in the final system. The products are intended for build in use in the final Class I system and to avoid risk of electric shock, products must only be connected to a supply mains with protective earth.

Servicing:

Instructions or reference information for repair of equipment parts are provided by the manufacturer. Please contact us for this information. Do not modify the product without authorization from Delta.

Critical Components:

These products are not authorized for use as critical components in nuclear control systems, life support systems or equipment for use in hazardous environments without the express written management approval from Delta.

Product Usage:

These products are designed to apply in medical, industrial, commercial and IT equipment which need to use DC voltages.

Environmental:

These products are IPX0, and therefore chemical/solvents, cleaning agents and other liquids must not be used. They shall be operated in dry locations to protect from moisture and are not suitable for using in an oxygen rich environment.

Environment:

This power supply is a switch mode power supply for use in applications within a Pollution Degree 2, overvoltage category II environment. Material Group IIIb PCB is used.

Input Parameters:

This product must be operated within the input parameters stated in the product limitations in this user manual.

Output Loading:

The power supply output power taken must not exceed the rating that is stated on label of the power supply, except as stated in the product limitations in this user manual.

End of Life Disposal:

The power supply contains components that require special disposal. The instructions shall be according to Directive 2012/19/EU of waste electrical and electronic equipment (WEEE) For end of life cycle, make sure that the power supply doesn't throw into general trash, and it must be handed over to the local recycle system.







CCC certification:

If the products are intended to apply CCC in final system, 1500W is the maximum power system can draw from the mains.

PMR Panel Mount Power Supply

PMR 1500W series / PMR-□V1K5W1BT□

1.2 Warning

	<p>There's no practical design can incorporate protection for operators or service personnel who do not take adequate safety precautions. Only authorized, qualified, properly trained personnel and operating personnel are allowed to work with the power supply. The appropriate personnel must be aware of the inherent dangers / hazardous associated with the servicing of power supply contains hazardous high voltage.</p>
	<p>There are double pole/neutral fusing inside the power supply</p>
	<p>The power supply has sharp metal edge, pay attention to this before installation to avoid injury.</p>
	<p>It is the power supply user's responsibility to use and operate the power supply in proper way for functionality and safety. Although Delta Electronics provides information for the power supply and potential hazards, but Delta Electronics assumes no responsibility for use and operating the power supply after sale.</p> <p>Delta Electronics assumes no responsibility if the power supply is not installed according this manual.</p> <p>Delta Electronics assumes no responsibility if the power supply is not correctly maintained according this manual.</p> <p>Delta Electronics assumes no responsibility for any if the power supply is modified in any way after sale.</p>
	<p>It is not allowed to disassemble the power supply without Delta's technical support or authorization, to avoid the injury by high voltage.</p>
	<p>Please take all required preventive measures with related hazards if any cover must be removed. When the need of removal is completed, please replace the covers immediately.</p>
	<p>Hazardous voltage exists inside the power supply whenever the AC main power is connected to the power supply. Moreover, hazardous voltage will continue to exist even after the power supply is disconnected from the AC input voltage after a certain period of time. This hazardous voltage exists in but not limited to following parts: Fuse, Fuse holder, Main Relay, Bridge rectifier, Bulk Capacitors, Main Power Circuits, Associated circuits on power input board, etc.</p> <p>Although bleeding resistors are added for energy stored capacitor to discharge after AC off, due to the possibility of component fault, the bleeding functionality may not work. Calibrated measurement equipment, for example, voltage meter, must be used to measure voltage to confirm it is within safe voltage range before access the parts.</p>

PMR Panel Mount Power Supply

PMR 1500W series / PMR-□V1K5W1BT□

2. General overview

2.1 General Description

The PMR-1K5 series of internal built power supplies come with universal AC input range from 85Vac to 264Vac. The PMR-1K5 series is certified for EMC standards according to EN 55032 for Industrial Technology Equipment (ITE) radio-frequency equipment. In addition, only recognized Japanese capacitors are used to ensure long product life.

The PMR-1K5 series comes with both medical and ITE safety approvals, including UL/CE/CCC (5000 meters), and CB certification. Designs are compliant with RoHS Directive 2011/65/EU for environmental protection, to avoid risk of opening of a branch circuit breaker, the product is tested on a 50A branch circuit, if used on a different branch circuit, additional testing may be necessary.

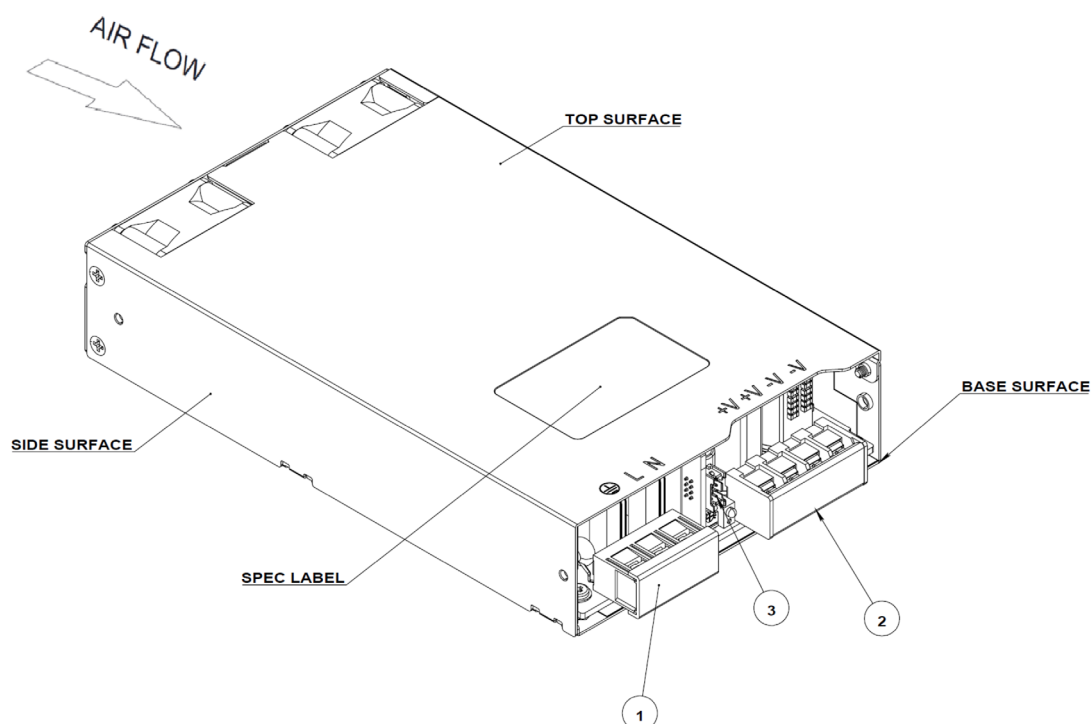

Fig. 1: Components of the PMR-1K5 series

1. AC/DC input terminal block (CN1)
2. DC output terminal (CN101)
3. Signal connector and Auxiliary DC Output (CN702)

PMR Panel Mount Power Supply

PMR 1500W series / PMR-□V1K5W1BT□

2.2 Connections

AC/DC input terminal block (CN1)

CN1 is the input connector, a standard screw type 3-pin connector with clamp washer and a terminal centres pitch distance of 9.5 mm (0.37 in).

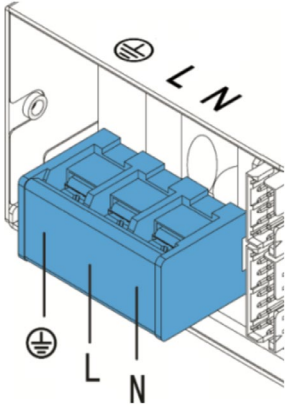

Pin	Assignment
N	Neutral
L	Line (Phase)
	Ground/Earth

Wire range: 12-18 AWG
 Screw torque: 0.79N.m (7 lb-in)
 Screws are suitable for slotted and Phillips head screwdrivers.

Fig. 2: AC/DC Input terminal block (CN1) – pin assignment

Table 1: AC/DC input terminal block (CN1) - pin assignment

Signal connector and Auxiliary DC Output (CN702)

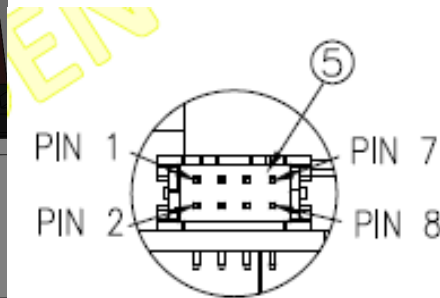
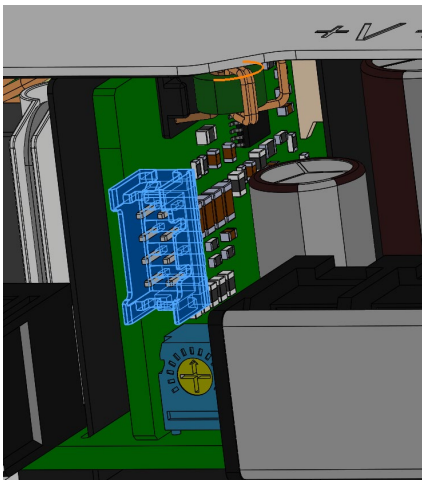

Fig. 3: Signal port and Auxiliary DC Output(CN702)

Fig. 4: Signal port and Auxiliary DC Output (CN702)

PMR Panel Mount Power Supply

PMR 1500W series / PMR-□V1K5W1BT□

Control Connector (CVILUX CI0108P1HDL-NH OR EQUIVALENT) Mating With CVILUX CI0108SD0L0 OR EQUIVALENT Terminal: CVILUX CI01TD21PE0 OR EQUIVALENT			
Pin 1	CURRENT SHARING	Pin 5	GND
Pin 2	REMOTE ON/OFF +	Pin 6	GND
Pin 3	GND	Pin 7	5V OUTPUT
Pin 4	REMOTE ON OFF -	Pin 8	5V OUTPUT

Table 2: Signal port and Auxiliary DC Output – Pin assignment

PMR Panel Mount Power Supply

PMR 1500W series / PMR-□V1K5W1BT□

Output voltage adjustment potentiometer

The Output voltage adjustment potentiometer is for output voltage adjustment within the range of specifications.

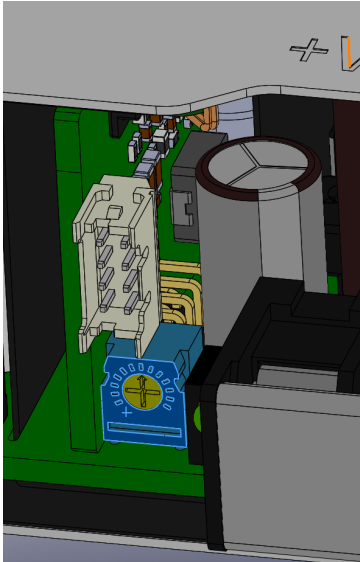

Fig. 7: Output voltage adjustment potentiometer

Main DC output terminal (CN101)

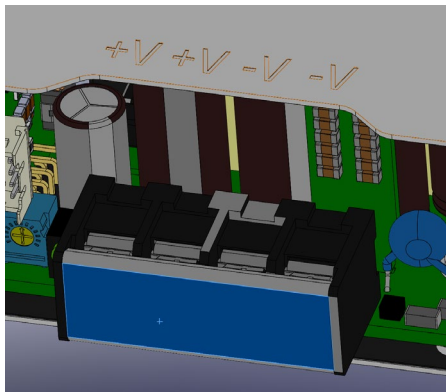

Fig. 8: Main DC Output terminal (CN101) – pin assignment

Pin	Assignment
+V(CN101)	Main Output +
+V(CN101)	Main Output +
-V(CN101)	Main DC Return
-V(CN101)	Main DC Return

Wire range: 4-12 AWG
 Screw torque: 1.77N.m (15.6 lb-in)
 Screws are suitable for slotted and Phillips head screwdrivers.

Table 4: DC output port (CN101) - pin assignment

PMR Panel Mount Power Supply

PMR 1500W series / PMR-□V1K5W1BT□

2.3 Installation Instruction

The Installer Requirement:

- Must have necessary electric knowledge and understand the risks of electric shock;
- Must read the safety warning from section 1.1-1.2 carefully
- Must fully understand the connections in 2.2 before installation.

Mounting orientations

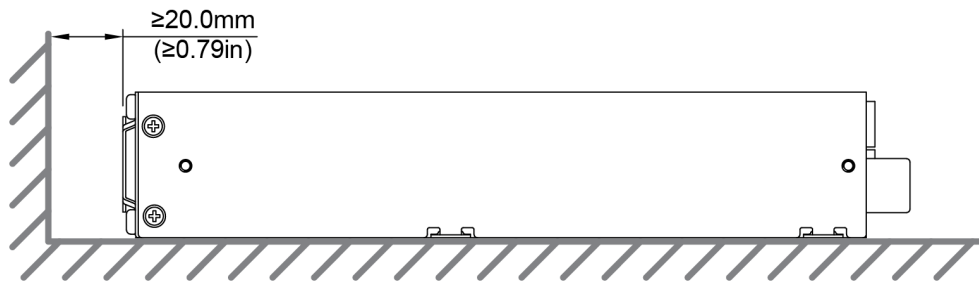

Fig. 9: Standard mounting orientation

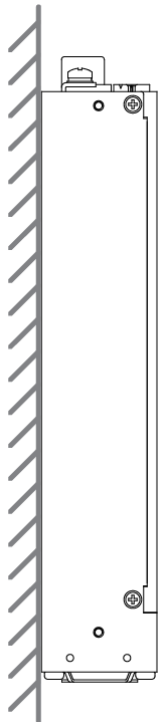

Fig.10: Vertical mounting

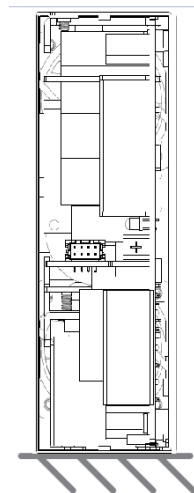

Fig. 11: Mounting on the right side

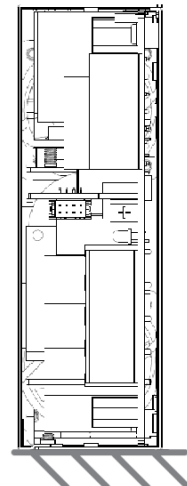

Fig. 12: Mounting on the left side

PMR Panel Mount Power Supply

PMR 1500W series / PMR-□V1K5W1BT□

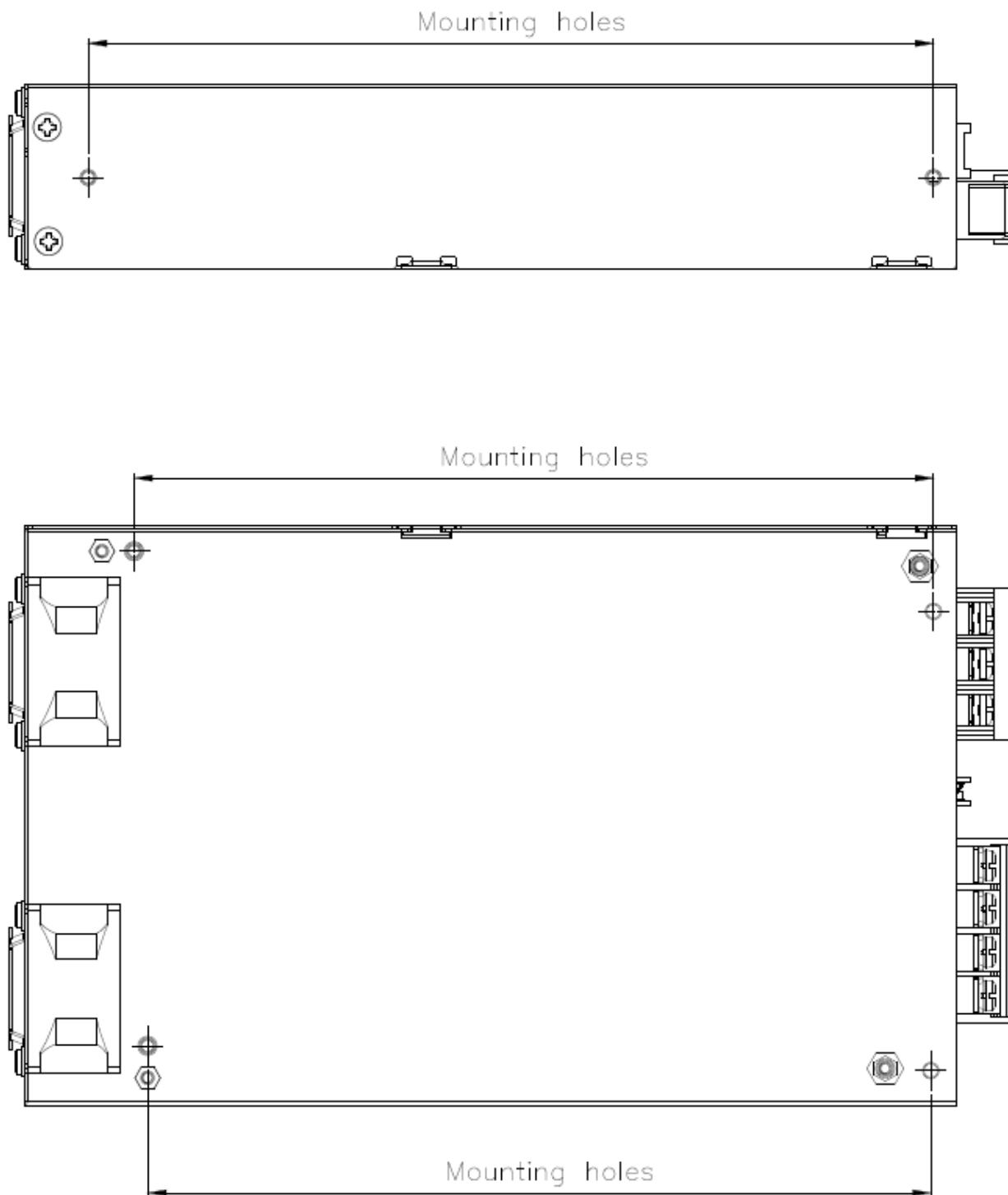

Fig. 13: Position of mounting holes

Note: Always keep ≥ 20 mm (0.79 in) space on the fan side and on the connector side to ensure proper airflow.

PMR Panel Mount Power Supply

PMR 1500W series / PMR-□V1K5W1BT□

Dimensional drawings

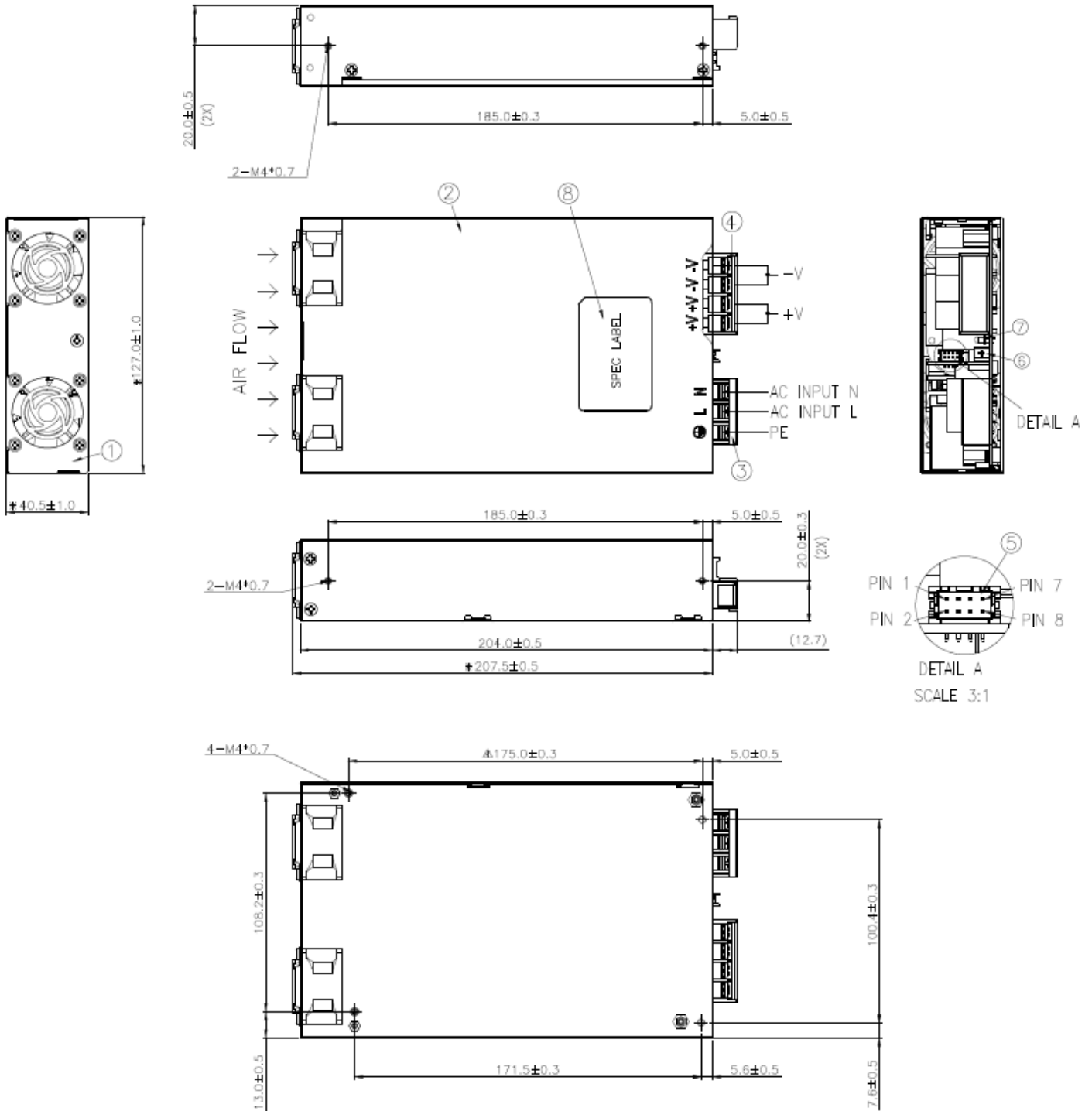

Fig. 14: Dimensional drawing PMR-1K5

PMR Panel Mount Power Supply

PMR 1500W series / PMR-□V1K5W1BT□

Note:

1. Base plate mounting, M4 thread holes, maximum penetration 3.0mm (0.12 inch) from outside face of chassis, maximum torque 9.0-10.0kgf.cm (7.8-8.6 inch.lbs).
2. Side mounting, M4 thread holes, maximum penetration 4.0mm (0.16inch) from outside face of chassis, maximum torque 9-10kgf.cm (7.8-8.6 inch.lbs).
3. CN101, M4 screw in four positions, maximum torque 9-10kgf.cm (7.8-8.6 inch.lbs).
4. CN1, M3.5 screw in two positions, maximum torque 6-7kgf.cm (5.2-6.1inch.lbs).
5. VR: clockwise is to increase the output voltage, anti-clockwise is to reduce the output voltage.

PMR Panel Mount Power Supply

PMR 1500W series / PMR-□V1K5W1BT□

3. Electrical Functions of Main output

3.1 Start-up timing

Start-up time is defined as the time duration from when the AC is applied with remote on_off signal enabled to the output voltage reaching to higher than 90% of its final steady value. PMR-1K5 series power supply can provide 1s max start up time to meet the fast power up requirement.

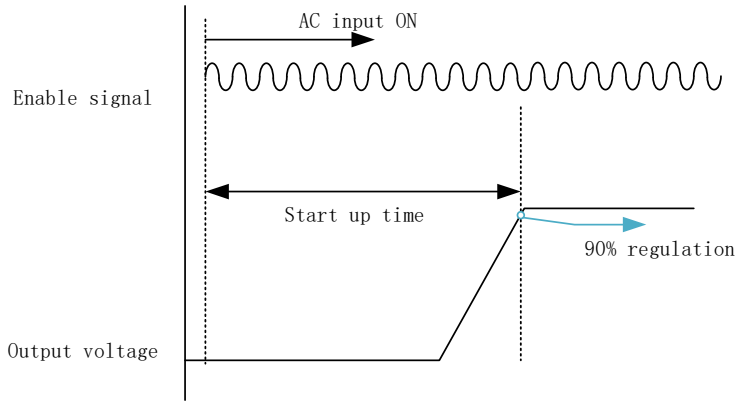

Fig. 15: Start-up timing sequence

The standard product sets the remote on_off signal to be enabled as default, if customer is choosing the reverse logic version, then remote on_off signal is required to be enabled before powering up the power supply, otherwise the startup time is determined by the time when the remote on_off signal is set to be enable.

When the power supply is originally disabled and then enabled by the remote on_off control signal, the enable time is 100ms max, this includes the output rise time to 90% regulation.

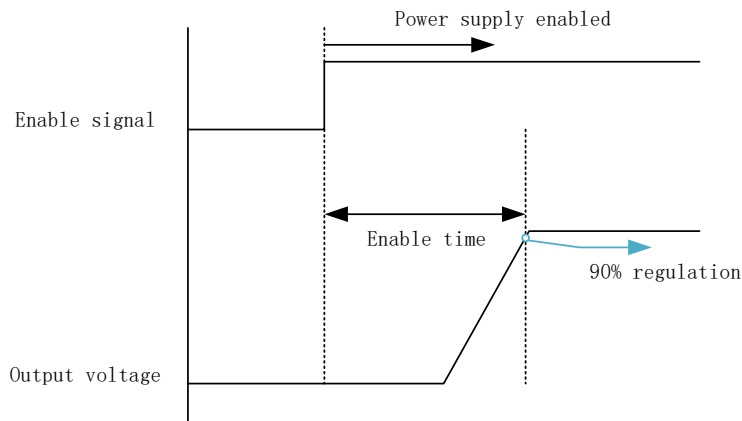

Fig. 16: Enable timing sequence

PMR Panel Mount Power Supply

PMR 1500W series / PMR-□V1K5W1BT□

3.2 Rise Time

Rise time is defined as the time from when the output voltage is higher than 10% regulation voltage to the point when the output voltage reaches 90% output regulation level. The rise time provided by PMR-1K5 series is 50ms max.

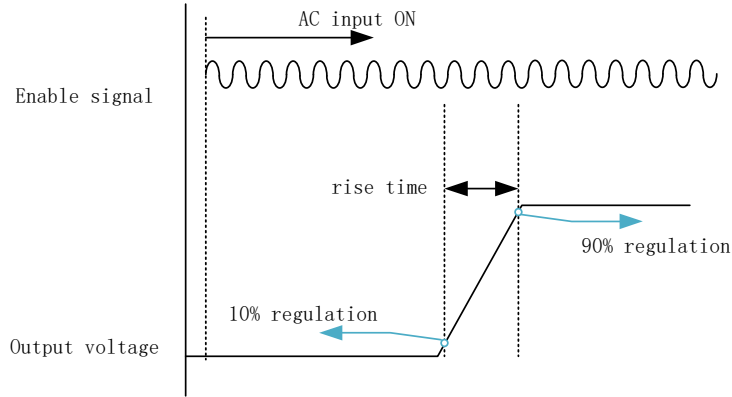

Fig. 17: Rise time sequence

3.3 Hold up time

Hold up time provide the system the necessary back up time from when AC is collapsed to the output voltage falls below 90% regulation value. As when AC input is off, it is depending on the internal power reserved in the power supply to support the output power, different output level will bring different hold time. PMR-1K5 defines the hold time with 1500W load, as long as the input voltage is within the normal input value, the hold time can be 12ms min, but if the load can be decreased to 1200W, the hold up time then can increase to 16ms min.

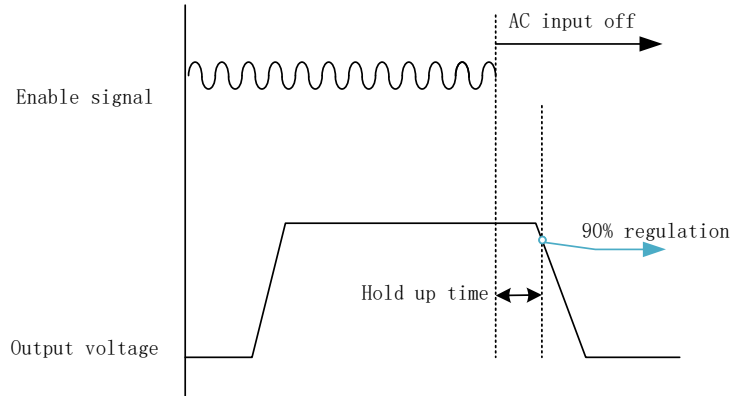

Fig. 18: Hold up time sequence

PMR Panel Mount Power Supply

PMR 1500W series / PMR-□V1K5W1BT□

3.4 Protections

3.4.1 Over voltage protection (OVP)

When the output voltage sees unusual high peak or the internal feedback control loop fails to lead the output voltage to be unusually high, power supply can sense the output voltage, if the output voltage is higher than certain limit (145% regulation max), the power converter will be disabled with latch mode, and require removal/re-application of input AC voltage in order to restart.. If the protection is not cleared, power supply will stay protected.

3.4.2 Over load

The power supply's Overload (OLP) Protections will be activated before output current under 130% of I_o (Max load). Upon such occurrence, V_o will start to drop. Once the power supply has reached its maximum power limit or triggers the under voltage limit, the protection will be activated and the power supply will go into "Hiccup mode" (Auto-Recovery). The power supply will recover once the fault condition causing the OLP is removed and I_o is back within the specified limit.

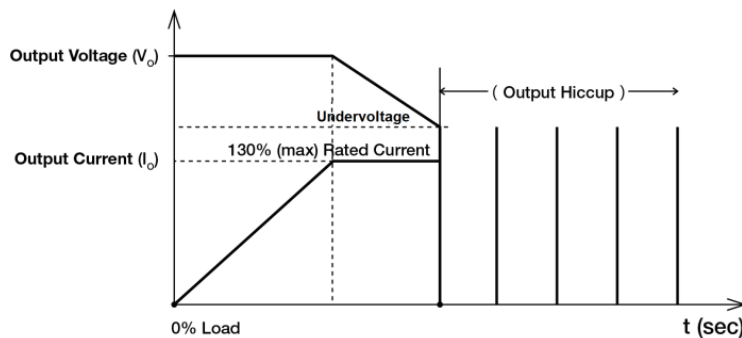

Fig. 19: Auto restart hiccup during OLP/OCP

Additionally, if the lout is >100% for a prolong period of time (depending on the load), the Over Temperature Protection (OTP) may be activated due to high temperature on critical components. The power supply will then go into latch mode.

3.4.3 Short circuit protection (SCP)

Output OLP/OCP function also provides protection against short circuits. When a short circuit is applied, the output current will operate in "Hiccup mode", The power supply will return to normal operation after the short circuit is removed.

3.4.4 Over temperature protection

As mentioned above, the power supply also has Over Temperature Protection (OTP). This is activated when the overload condition persists for an extended duration and the output current is below the overload trigger point but >100% load. In the event of a higher operating temperature condition at 100% load, the power supply will run into OTP when the surrounding air temperature is higher than the operating temperature. When activated, the output voltage will go into latch mode.

To re-enable the power supply output, it needs to,

- A. Turn off the AC input
- B. Remove the fault temperature ambient condition
- C. Let power supply cool down
- D. Turn on the AC again

PMR Panel Mount Power Supply

PMR 1500W series / PMR-□V1K5W1BT□

3.5 Remote On_Off control

Remote On_off control allows customer to easily control the power supply from system level point of view, PMR-1K5 series uses an isolated diode located within the power supply. The remote control signal can be used to enable or disable only the main output. When the main output is disabled, the +5V Standby output will stop to operate.

System can use a switch to conduct to disable the main output.

SW OFF (open)	SW ON (close)
Power supply turn on	Power supply turn off

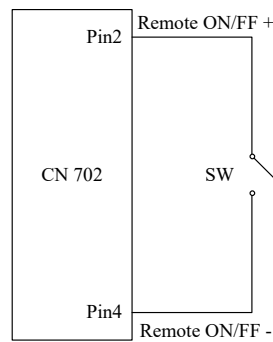

Fig. 20: Remote On_off connection

PMR Panel Mount Power Supply

PMR 1500W series / PMR-□V1K5W1BT□

3.6 Voltage Adjustment

The power supply provides a potentiometer for user to adjust the output voltage. The output voltage is designed to be able to adjust up to $\pm 10\%$ of rated voltage, when the output is adjusted below nominal value, the maximum output current is the same as the nominal output, when the output is adjusted above nominal value, the output power cannot exceed the nominal maximum power (the maximum output current will be reduced accordingly).

PMR Panel Mount Power Supply

PMR 1500W series / PMR-□V1K5W1BT□

3.7 Parallel operation

PMR-1K5 series has an active current sharing circuit for the main output; it can realize the output current to be balanced when customer is using two or more power supplies in parallel to achieve higher output power.

A one wire current share bus is used to achieve current sharing between units, the current share bus must be connected together among different units (pin 1 of CN702, refer to power supply structure and pin assignment in section 2.2).

The difference in output voltage can impact the current sharing accuracy, all the units to be paralleled, please use the voltage adjustment function to set the voltage to be ± 50 mV of the set value.

If system application more than 2pcs power supplies need to be paralleled please contact Delta for technical support.

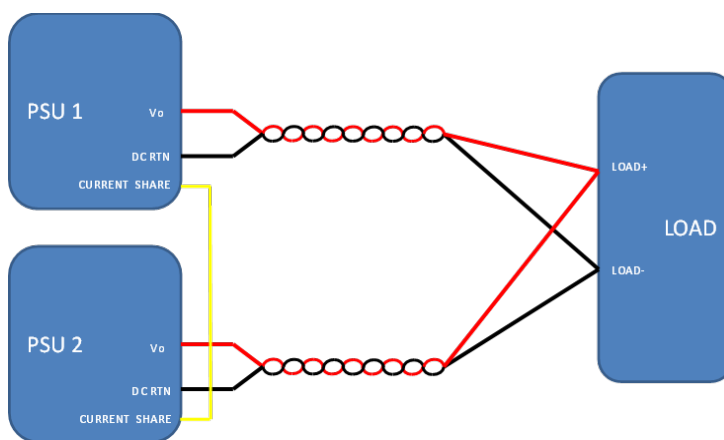

Fig. 25: parallel connection without remote sense